

LEARNING MADE EASY

Extreme Networks Special Edition

Wi-Fi 6

for
dummies[®]
A Wiley Brand



Enhanced 2.4 and
5 GHz spectral efficiency

Uplink and downlink
multi-user connectivity

Extended battery life for
client and IoT devices

Compliments
of



Extreme[™]
Customer-Driven Networking

David Coleman – CWNE #4

About Extreme Networks

Extreme Networks, Inc. (EXTR) delivers software-driven solutions from the enterprise edge to the cloud that are agile, adaptive, and secure to enable digital transformation. Our 100% in-sourced services and support are number one in the industry. Even with 50,000 customers globally, including half of the Fortune 50 and some of the world's leading names in business, hospitality, retail, transportation and logistics, education, government, healthcare and manufacturing, we remain nimble and responsive to ensure customer and partner success. We call this Customer-Driven Networking™. Founded in 1996, Extreme is headquartered in San Jose, California. For more information, visit www.extremenetworks.com or call 1-888-257-3000.

Wi-Fi 6

**for
dummies[®]**
A Wiley Brand



Wi-Fi 6

Extreme Networks Special Edition

by David Coleman – CWNE #4

for
dummies[®]
A Wiley Brand

Wi-Fi 6 For Dummies® , Extreme Networks Special Edition

Published by

John Wiley & Sons, Inc.

111 River St.

Hoboken, NJ 07030-5774

www.wiley.com

Copyright © 2020 by John Wiley & Sons, Inc., Hoboken, New Jersey

No part of this publication may be reproduced, stored in a retrieval system or transmitted in any form or by any means, electronic, mechanical, photocopying, recording, scanning or otherwise, except as permitted under Sections 107 or 108 of the 1976 United States Copyright Act, without the prior written permission of the Publisher. Requests to the Publisher for permission should be addressed to the Permissions Department, John Wiley & Sons, Inc., 111 River Street, Hoboken, NJ 07030, (201) 748-6011, fax (201) 748-6008, or online at <http://www.wiley.com/go/permissions>.

Trademarks: Wiley, For Dummies, the Dummies Man logo, The Dummies Way, Dummies.com, Making Everything Easier, and related trade dress are trademarks or registered trademarks of John Wiley & Sons, Inc. and/or its affiliates in the United States and other countries, and may not be used without written permission. Extreme Networks and the Extreme Networks logo are trademarks or registered trademarks of Extreme Networks, Inc. in the United States and other countries. All other trademarks are the property of their respective owners. John Wiley & Sons, Inc., is not associated with any product or vendor mentioned in this book.

LIMIT OF LIABILITY/DISCLAIMER OF WARRANTY: THE PUBLISHER AND THE AUTHOR MAKE NO REPRESENTATIONS OR WARRANTIES WITH RESPECT TO THE ACCURACY OR COMPLETENESS OF THE CONTENTS OF THIS WORK AND SPECIFICALLY DISCLAIM ALL WARRANTIES, INCLUDING WITHOUT LIMITATION WARRANTIES OF FITNESS FOR A PARTICULAR PURPOSE. NO WARRANTY MAY BE CREATED OR EXTENDED BY SALES OR PROMOTIONAL MATERIALS. THE ADVICE AND STRATEGIES CONTAINED HEREIN MAY NOT BE SUITABLE FOR EVERY SITUATION. THIS WORK IS SOLD WITH THE UNDERSTANDING THAT THE PUBLISHER IS NOT ENGAGED IN RENDERING LEGAL, ACCOUNTING, OR OTHER PROFESSIONAL SERVICES. IF PROFESSIONAL ASSISTANCE IS REQUIRED, THE SERVICES OF A COMPETENT PROFESSIONAL PERSON SHOULD BE SOUGHT. NEITHER THE PUBLISHER NOR THE AUTHOR SHALL BE LIABLE FOR DAMAGES ARISING HEREFROM. THE FACT THAT AN ORGANIZATION OR WEBSITE IS REFERRED TO IN THIS WORK AS A CITATION AND/OR A POTENTIAL SOURCE OF FURTHER INFORMATION DOES NOT MEAN THAT THE AUTHOR OR THE PUBLISHER ENDORSES THE INFORMATION THE ORGANIZATION OR WEBSITE MAY PROVIDE OR RECOMMENDATIONS IT MAY MAKE. FURTHER, READERS SHOULD BE AWARE THAT INTERNET WEBSITES LISTED IN THIS WORK MAY HAVE CHANGED OR DISAPPEARED BETWEEN WHEN THIS WORK WAS WRITTEN AND WHEN IT IS READ.

For general information on our other products and services, or how to create a custom *For Dummies* book for your business or organization, please contact our Business Development Department in the U.S. at 877-409-4177, contact info@dummies.biz, or visit www.wiley.com/go/custompub. For information about licensing the *For Dummies* brand for products or services, contact BrandedRights&Licenses@Wiley.com.

ISBN 978-1-119-64285-5 (pbk); ISBN 978-1-119-64286-2 (ebk)

Manufactured in the United States of America

10 9 8 7 6 5 4 3 2 1

Publisher's Acknowledgments

Some of the people who helped bring this book to market include the following:

Project Editor: Jen Bingham

Acquisitions Editor: Katie Mohr

Editorial Manager: Rev Mengle

Business Development

Representative: Karen Hattan

Production Editor:

Tamilmani Varadharaj

Contents at a Glance

| | |
|--|----|
| Introduction | 1 |
| CHAPTER 1: Wi-Fi Traffic Jam | 5 |
| CHAPTER 2: The Secret Sauce of Wi-Fi 6: OFDMA | 15 |
| CHAPTER 3: Multi-User Technology #2: MU-MIMO | 31 |
| CHAPTER 4: BSS Color and Spatial Reuse | 37 |
| CHAPTER 5: Additional Wi-Fi 6 Enhancements | 43 |
| CHAPTER 6: Wi-Fi 6 Key Questions | 51 |
| CHAPTER 7: Extreme Wi-Fi 6 APs | 61 |
| CHAPTER 8: Ten Things to Know about Wi-Fi 6 | 69 |

Table of Contents

| | |
|--|-----------|
| INTRODUCTION | 1 |
| About This Book | 1 |
| Foolish Assumptions | 2 |
| Icons Used in This Book | 2 |
| Beyond the Book | 2 |
| Where to Go from Here | 3 |
| CHAPTER 1: Wi-Fi Traffic Jam | 5 |
| Wi-Fi Timeline | 5 |
| 802.11ax = Wi-Fi 6 | 8 |
| Wi-Fi Traffic Congestion | 9 |
| Wi-Fi 6 — More than Just Speeds and Feeds | 11 |
| Multi-User | 13 |
| CHAPTER 2: The Secret Sauce of Wi-Fi 6: OFDMA | 15 |
| OFDMA | 15 |
| Subcarriers | 16 |
| Resource Units (RUs) | 18 |
| Trigger Frames | 22 |
| DL-OFDMA | 24 |
| UL-OFDMA | 26 |
| Buffer Status Reports | 27 |
| OMI | 29 |
| CHAPTER 3: Multi-User Technology #2: MU-MIMO | 31 |
| Introducing MU-MIMO | 31 |
| I Need Some Space | 33 |
| Bridge over Troubled Waters | 35 |
| What Is the Difference? | 35 |
| CHAPTER 4: BSS Color and Spatial Reuse | 37 |
| OBSS | 37 |
| BSS Color | 39 |
| Spatial Reuse Operation | 40 |

| | |
|--|----|
| CHAPTER 5: Additional Wi-Fi 6 Enhancements | 43 |
| Target Wake Time (TWT)..... | 43 |
| 1024-QAM..... | 44 |
| Long Symbol Time and Guard Intervals | 46 |
| New PHY Headers | 47 |
| 20 MHz-Only Mode | 48 |
| Multi-TID AMPDU..... | 49 |
| CHAPTER 6: Wi-Fi 6 Key Questions | 51 |
| Clients | 51 |
| MultiGig | 52 |
| Power over Ethernet | 54 |
| 4x4:4 versus 8x8:8..... | 56 |
| 80 MHz Channels..... | 58 |
| CHAPTER 7: Extreme Wi-Fi 6 APs | 61 |
| AP505i | 61 |
| AP510i and AP510e | 62 |
| AP510C and AP510CX | 62 |
| AP560i, AP560h, and 560u | 63 |
| Our Wi-Fi 6 AP Family Is Growing! | 66 |
| ExtremeCloud IQ | 67 |
| CHAPTER 8: Ten Things to Know about Wi-Fi 6 | 69 |

Introduction

Previous generations of Wi-Fi (going back about 20 years) focused on increasing data rates and speed. Wi-Fi 6 (also known as 802.11ax) is the new generation of Wi-Fi technology with a new focus on efficiency and performance. Wi-Fi 6 technology is all about better and more efficient use of the existing radio frequency medium.

Wi-Fi 6 handles client density more efficiently through a new channel-sharing capability that promises true multi-user communications on both the downlink and uplink. Wi-Fi 6 also uses a new client power-saving mechanism that schedules wake-times to improve client battery life.

In this book, you learn about Wi-Fi 6 efficiency enhancements as well as the real-world implications of this historic evolution of Wi-Fi technology. You will also get an introduction to the robust offering of Wi-Fi 6 access points from Extreme Networks.

About This Book

Wi-Fi 6 For Dummies, Extreme Networks Special Edition, consists of eight chapters that explore:

- » Wi-Fi Traffic Jam (Chapter 1)
- » The Secret Sauce of Wi-Fi 6: OFDMA (Chapter 2)
- » Multi-User Technology #2: MU-MIMO (Chapter 3)
- » BSS Color and Spatial Reuse (Chapter 4)
- » Additional Wi-Fi 6 Enhancements (Chapter 5)
- » Wi-Fi 6 Key Questions (Chapter 6)
- » Extreme Networks Wi-Fi 6 APs (Chapter 7)
- » Ten Key Things to Remember about Wi-Fi 6 (Chapter 8)

Foolish Assumptions

It has been said that most assumptions have outlived their usefulness, but we assume a few things nonetheless!

Mainly, we assume that you are an IT infrastructure professional — someone with networking, wireless, or cloud in their title — and that you work for a medium to large organization or enterprise with robust Wi-Fi business requirements and you are interested in what is next for Wi-Fi.

If any of these assumptions describe you, then this book is for you! If none of these assumptions describe you, keep reading anyway. It is a great book and when you finish reading it, you will know a few things about the next generation of Wi-Fi.

Icons Used in This Book

Throughout this book, I occasionally use special icons to call attention to important information. Here is what to expect:



REMEMBER

This icon points out information you should commit to your non-volatile memory, your gray matter, or your noggin — along with anniversaries and birthdays!



TECHNICAL
STUFF

You will not find a map of the human genome here, but if you seek to attain the seventh level of NERD-vana, perk up! This icon explains the jargon beneath the jargon!



TIP

Tips are appreciated, never expected — and we sure hope you will appreciate these tips. This icon points out useful nuggets of information.

Beyond the Book

There is only so much I can cover in 80 short pages, so if you find yourself at the end of this book, thinking, “Where can I learn more?” just go to www.wifi6fordummies.com. You can also read

the latest edition of David Coleman and David Westcott's *CWNA Certified Wireless Network Administrator Study Guide: Exam CWNA-107* (Wiley).

Where to Go from Here

If you do not know where you are going, any chapter will get you there — but Chapter 1 might be a good place to start! However, if you see a particular topic that piques your interest, feel free to jump ahead to that chapter. Each chapter is written to stand on its own, so you can read this book in any order that suits you (though I do not recommend upside down or backwards).

IN THIS CHAPTER

- » Looking at the timeline of Wi-Fi technology
- » Introducing 802.11ax and Wi-Fi 6
- » Considering the current Wi-Fi traffic jam
- » Recognizing that Wi-Fi 6 is about efficiency
- » Understanding the definition of multi-user

Chapter 1

Wi-Fi Traffic Jam

In this chapter, you look back at the evolution of Wi-Fi standards and the challenges that exist in current Wi-Fi networks, as well as the next generation of Wi-Fi technology that defines efficiency enhancements: Wi-Fi 6.

Wi-Fi Timeline

The Institute of Electrical and Electronics Engineers (IEEE) is the professional society that creates and maintains standards that we use for communications, such as the 802.3 Ethernet standard for wired networking. Since 1997, the IEEE has maintained the 802.11 standard for *wireless local area network (WLAN)* technology.



TECHNICAL
STUFF

In your daily life, you probably instead use the familiar phrase *Wi-Fi* to discuss the same technology. Many people mistakenly assume that Wi-Fi is an acronym for the phrase *wireless fidelity* (much like hi-fi is short for *high fidelity*), but Wi-Fi is simply a brand name used to market 802.11 WLAN technology. The name that people will always recognize for the technology is Wi-Fi.

As a matter of fact, Wi-Fi has become an essential part of our daily worldwide communications culture. Wi-Fi technology is ingrained into our everyday lives.

The 802.11 working group has about 400 active members from more than 200 wireless companies. It consists of standing committees, study groups, and numerous *task groups*. Over the years, various 802.11 task groups have been in charge of revising and amending the original standard. Each group is assigned a letter from the alphabet, and it is common to hear the term 802.11 *alphabet soup* when referring to all the amendments created by the multiple 802.11 task groups. The goal of each amendment is to enhance 802.11 technology. In the past, many of the enhancements had a primary emphasis on higher data rates and faster speeds (see Table 1-1.) For example, 802.11b introduced data rates of up to 11 Mbps (megabits per second). 802.11a and 802.11g introduced data rates of 54 Mbps. 802.11n and 802.11ac enhanced data rates much further.

TABLE 1-1 Wi-Fi Timeline

| Year | Amendment | Data rates | 2.4 GHz | 5 GHz | RF technology | Radios |
|------|---------------|-----------------------|---------|-------|---------------|---------|
| 1997 | 802.11 legacy | 1 and 2 Mbps | √ | | DSSS and FHSS | SISO |
| 1999 | 802.11a | 6 - 54 Mbps | | √ | OFDM | SISO |
| 1999 | 802.11b | 1, 2, 5.5 and 11 Mbps | √ | | HR-DSSS | SISO |
| 2003 | 802.11g | 6 - 54 Mbps | √ | | OFDM | SISO |
| 2009 | 802.11n | Up to 600 Mbps | √ | √ | OFDM | MIMO |
| 2013 | 802.11ac | Up to 6.93 Gbps | | √ | OFDM | MU-MIMO |

In 1999, wireless was commercially introduced as a “nice to have” feature with the 802.11a and 802.11b ratifications. 802.11b, the most commonly used standard at the time, had very low speeds — only up to 11 Mbps (much lower than most Ethernet wired networks installed at the time) — but there were no Wi-Fi mobile devices and very few laptops, so 11 Mbps was fast enough. By 2003, Wi-Fi-enabled mobile devices were being introduced in the market and portable laptops became common for both business and personal use. The 802.11g standard was subsequently ratified, delivering up to 54 Mbps speeds on the 2.4 GHz frequency band.

In 2007, Apple introduced the first iPhone and the smartphone became a modern reality. The 802.11n standard followed in 2009, delivering 100 Mbps of usable throughput. The 802.11n standard also brought about faster theoretical data rates of up to 600 Mbps and supported both 2.4 and 5 GHz devices. 802.11n was the last big paradigm shift in Wi-Fi technology when we switched from *single-input single-output (SISO)* radios to *multiple-input multiple-output (MIMO)* radios. We went from a time when an RF phenomenon known as multipath became constructive instead of destructive. By 2012, wireless mobile devices such as smartphones surpassed personal computer sales.

Introduced in 2013, 802.11ac expanded and in some cases simplified many of the technologies of 802.11n: Even higher data rates prevailed; however, 802.11ac only operates in the 5 GHz frequency band. Although data rates of up to 6.93 Gbps are theoretically possible with 802.11ac, in the real world, data rates of up to 400 – 800 Mbps are more likely. 802.11ac also introduced a multi-user technology known as multi-user MIMO (MU-MIMO); however, the implementation has been sparse.

As you can see, over the years, the main emphasis has been on faster speeds and higher data rates to meet the high-density demands in enterprise WLANs. However, there is a big misconception that data rates are the same as actual throughput. And furthermore, speed can be overrated. What good is a Ferrari that can travel at 300 km per hour if the Ferrari is stuck in traffic gridlock?

802.11ax = Wi-Fi 6

802.11ax is an IEEE draft amendment that defines modifications to the 802.11 Physical (PHY) layer and the Medium Access Control (MAC) sublayer for *high efficiency* operations in frequency bands between 1 GHz and 6 GHz. Much like very high throughput is the technical term for 802.11ac, high efficiency is the technical term for 802.11ax.

The Wi-Fi Alliance (www.wi-fi.org) is a global, nonprofit industry association of about 800 member companies devoted to promoting the growth of WLANs. One of the primary tasks of the Wi-Fi Alliance is to market the Wi-Fi brand and raise consumer awareness of new 802.11 technologies as they become available. The Wi-Fi Alliance's main task is to ensure the interoperability of WLAN products by providing certification testing. Products that pass the Wi-Fi certification process receive a *Wi-Fi Interoperability Certificate* that provides detailed information about the individual product's Wi-Fi certifications.



REMEMBER

Recently, the Wi-Fi Alliance adopted a new generational naming convention for Wi-Fi technologies. The goal is that the new naming convention will be easier to understand for the average consumer as opposed to the alphabet-soup naming used by the IEEE. Because 802.11ax technology is such a major paradigm shift from previous versions of 802.11 technology, it has been bestowed with the generational name of *Wi-Fi 6*. Older versions of 802.11 technology also align with this new naming convention. For example, 802.11ac can be referenced as Wi-Fi 5 and 802.11n is Wi-Fi 4 as shown in Figure 1-1.

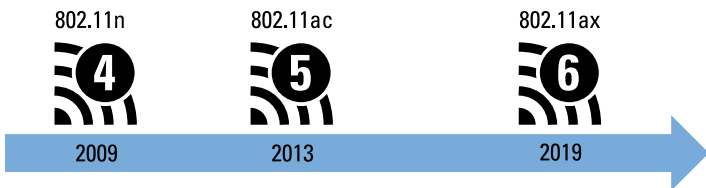

FIGURE 1-1: Generations of Wi-Fi.



TIP

Throughout this book, I use both the IEEE 802.11 terminology and the Wi-Fi Alliance generational terminology. 802.11ax and Wi-Fi 6 mean the same thing, but the term Wi-Fi 6 will be more prevalent with the general population. Geeky WLAN professionals might use term 802.11ax, while your grandma will understand the generational name of Wi-Fi 6.

Wi-Fi Traffic Congestion

Although Wi-Fi is a resilient technology, it has not necessarily been efficient. Wi-Fi operates at both layer 1 and layer 2 of the OSI model and the inefficiency exists at both layers.



REMEMBER

Historically, previous 802.11 amendments defined technologies that gave us higher data rates and wider channels but did not address efficiency. An often-used analogy is that faster cars and bigger highways have been built, but traffic jams still exist. Despite the higher data rates and 40/80/160 MHz channels used by 802.11n/ac radios, multiple factors contribute to the Wi-Fi traffic congestion, which do not provide for an efficient use of the medium.

So why exactly is there a Wi-Fi traffic jam? 802.11 data rates are not TCP throughput. Always remember that *radio frequency (RF)* is a half-duplex medium and that the 802.11 medium contention protocol of CSMA/CA consumes much of the available bandwidth. In laboratory conditions, TCP throughput of 60 to 70 percent of the operational data rate can be achieved using 802.11n/ac communication between one access point (AP) and one client. The aggregate throughput numbers are considerably less in real-world environments with active participation of multiple Wi-Fi clients communicating through an AP. As more clients contend for the medium, the medium contention overhead increases significantly, and efficiency drops. Therefore, the aggregate throughput is usually at best 50 percent of the advertised 802.11 data rate. Not very efficient.

What else contributes to Wi-Fi traffic congestion? Because legacy Wi-Fi clients often still participate in enterprise, RTS/CTS protection mechanisms are needed, which contributes to the inefficiency. As shown in Figure 1-2, about 60 percent of all Wi-Fi traffic is 802.11 control frames, and 15 percent is 802.11 management

frames. Control and management frames consume 75 percent of the usable airtime, and only 25 percent of Wi-Fi traffic is used for 802.11 data frames. Additionally, layer 2 retransmissions as a result of either RF interference or a poorly designed WLAN, can also contribute to 802.11 inefficiency.

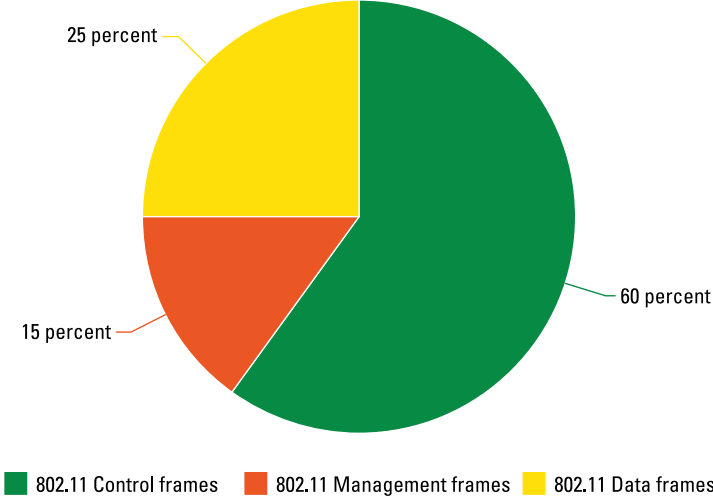

FIGURE 1-2: 802.11 traffic.

High data rates are useful for a large data payload; however, the bulk of 802.11 data frames (75–80 percent) are small and under 256 bytes, as shown in Figure 1-3. Each small frame requires a PHY header, a MAC header, and a trailer. The result is excessive PHY/MAC overhead as well as medium contention overhead for each small frame. Small frames can be aggregated to reduce the overhead; however, in most cases, the small frames are not aggregated, because they must be delivered sequentially due to the higher layer application protocols. For example, VoIP packets cannot be aggregated, because they must arrive sequentially.

Despite the higher data rates and wide channels that can be used by 802.11n/ac radios, the result is Wi-Fi traffic congestion. Automobile traffic congestion can result in drivers becoming frustrated and thereby engaging in road rage. Wi-Fi 6 (802.11ax) technology is all about better 802.11 traffic management and hopefully eliminating Wi-Fi radio rage.

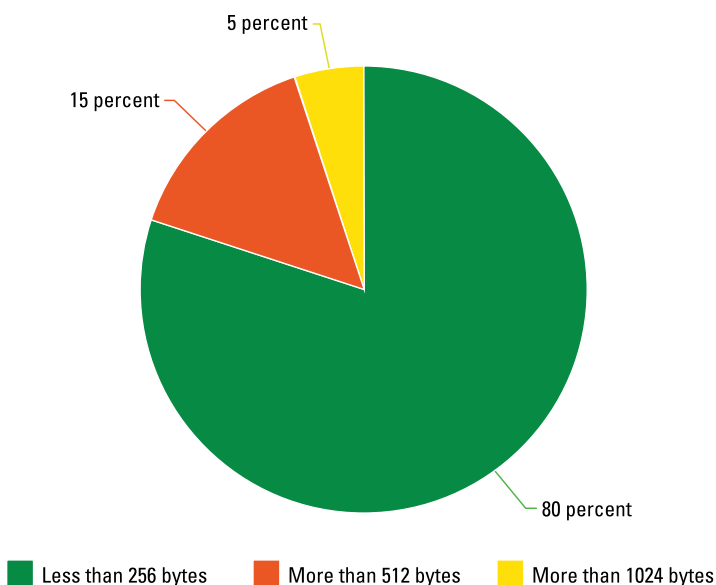

FIGURE 1-3: 802.11 data frame size.

Wi-Fi 6 — More than Just Speeds and Feeds

Wi-Fi 6 (802.11ax) technology is all about better and more efficient use of the existing radio frequency medium. Higher data rates and wider channels are not the goals of Wi-Fi 6. The goal is better and more efficient 802.11 traffic management. Most of the Wi-Fi 6 enhancements are at the PHY layer and involve a new multi-user version of OFDM technology, as opposed to the single-user OFDM technology already used by 802.11a/g/n/ac radios. Another significant Wi-Fi 6 change is that an access point (AP) can actually supervise both downlink and uplink transmissions to multiple client radios while the AP has control of the medium. In addition to these multi-user efficiency enhancements, Wi-Fi 6 (802.11ax) radios will be backward compatible with 802.11a/b/g/n/ac radios. Table 1-2 shows a high-level comparison of 802.11n, 802.11ac, and 802.11ax capabilities. Please note that unlike 802.11ac radios,

which can transmit only on the 5 GHz frequency band, 802.11ax radios can operate on both the 2.4 GHz and 5 GHz frequency bands.

As you can see in Table 1-2, Wi-Fi 6 does support 40 MHz, 80 MHz, and 160 MHz channels. For the bulk of the discussion of Wi-Fi 6 communication, however, I will focus on 20 MHz channels. As a matter of fact, the key benefits of Wi-Fi 6 will be a result of the partitioning of a 20 MHz channel into smaller sub-channels using a multi-user version of OFDM called orthogonal frequency division multiple access (OFDMA).

TABLE 1-2 802.11n, 802.11ac, and 802.11ax comparison

| | 802.11n (Wi-Fi 4) | 802.11ac (Wi-Fi 5) | 802.11ax (Wi-Fi 6) |
|-------------------------------|--|-------------------------------------|---|
| Frequency bands | 2.4 GHz and 5 GHz | 5 GHz only | 2.4 GHz, 5 GHz, 6 GHz |
| Channel size (MHz) | 20, 40 | 20, 40, 80, 80 + 80, and 160 | 20, 40, 80, 80 + 80, and 160 |
| Frequency multiplexing | OFDM | OFDM | OFDM and OFDMA |
| OFDM symbol Time (μs) | 3.2 | 3.2 | 12.8 |
| Guard interval (μs) | .04 or .08 | .04 or .08 | .08, 1.6, or 3.2 |
| Total symbol time (μs) | 3.6 or 4.0 | 3.6 or 4.0 | 13.6, 14.4, or 16.0 |
| Modulation | Binary Phase-Shift Keying (BPSK), Quadrature Phase-Shift Keying (QPSK), 16-QAM, 64-QAM | BPSK, QPSK, 16-QAM, 64-QAM, 256-QAM | BPSK, QPSK, 16-QAM, 64-QAM, 256-QAM, 1024-QAM |
| MU-MIMO | N/A | DL | DL and UL |
| OFDMA | N/A | N/A | DL and UL |

Multi-User

The term *multi-user (MU)* simply means that transmissions between an AP and multiple clients can occur at the same time, depending on the supported technology. However, the MU terminology can be very confusing when discussing Wi-Fi 6. MU capabilities exist for both OFDMA and MU-MIMO. I will explain the key differences later in this book.

Wi-Fi 6 makes use of both multi-user technologies, OFDMA and MU-MIMO. Do not confuse OFDMA with MU-MIMO. OFDMA allows for multiple-user access by subdividing a channel (see Chapter 2). MU-MIMO allows for multiple-user access by using different spatial streams (see Chapter 3). If I reference the car and road analogy discussed earlier, OFDMA uses a single road subdivided into multiple lanes for use by different cars at the same time, whereas MU-MIMO uses different single lane roads to arrive at the same destination.



REMEMBER

When discussing Wi-Fi 6, there is often a lot of confusion because many people may already be somewhat familiar with MU-MIMO technology introduced with 802.11ac (Wi-Fi 5). What most people are not familiar with is the multi-user technology of OFDMA. Most of the efficiency benefits of Wi-Fi 6 are a result of multi-user OFDMA.

IN THIS CHAPTER

- » Differentiating between OFDM and OFDMA
- » Understanding resource units, trigger frames, and buffer status reports
- » Recognizing the efficiency benefits of uplink and downlink OFDMA
- » Explaining operating mode indication

Chapter 2

The Secret Sauce of Wi-Fi 6: OFDMA

In this chapter, you learn about a multi-user technology called OFDMA, which is the main ingredient of Wi-Fi 6 technology.

OFDMA

Orthogonal frequency division multiple access (OFDMA) is arguably the most important new Wi-Fi 6 capability. Legacy 802.11a/g/n/ac radios currently use orthogonal frequency division multiplexing (OFDM) for single-user transmissions on any given channel. Wi-Fi 6 radios utilize orthogonal frequency division multiple access (OFDMA), which is a multi-user version of the OFDM digital-modulation technology. OFDMA subdivides a Wi-Fi channel into smaller frequency allocations, called *resource units (RUs)*, thereby enabling an access point (AP) to synchronize communication (uplink and downlink) with multiple individual clients assigned to specific RUs. By subdividing the channel, small frames can be simultaneously transmitted to multiple users in parallel.



TIP

OFDMA is ideal for most network applications and results in better frequency reuse, reduced latency, and increased efficiency.

Think of OFDMA as a technology that partitions a Wi-Fi channel into smaller subchannels so that simultaneous multiple-user transmissions can occur. For example, a traditional 20 MHz channel might be partitioned into as many as nine smaller subchannels. Using OFDMA, a Wi-Fi 6 AP could simultaneously transmit small frames to nine Wi-Fi 6 clients. The Wi-Fi CERTIFIED 6 certification program from the Wi-Fi Alliance currently validates up to four resource units.

OFDMA is a much more efficient use of the medium for smaller frames. The simultaneous transmission cuts down on excessive overhead at the medium access control (MAC) sublayer, as well as medium contention overhead. The AP can allocate the whole channel to a single user or partition it to serve multiple users simultaneously, based on client traffic needs. The goal of OFDMA is better use of the available frequency space. OFDMA technology has been time-tested with other RF communications. For example, OFDMA is used for downlink LTE cellular communications.

Subcarriers

Both OFDM and OFDMA divide a channel into subcarriers through a mathematical function known as an inverse fast Fourier transform (IFFT). The spacing of the subcarriers is orthogonal, so they do not interfere with one another despite the lack of guard bands between them. This creates signal nulls in the adjacent subcarrier frequencies and prevents intercarrier interference (ICI).

What are some of the key differences between OFDM and OFDMA? As shown in Figure 2-1, a 20 MHz 802.11n/ac channel consists of 64 subcarriers. Fifty-two of the subcarriers are used to carry modulated data; four of the subcarriers function as pilot carriers; and eight of the subcarriers serve as guard bands. OFDM subcarriers are sometimes also referred to as OFDM *tones*. In this book, I use both terms interchangeably. Each OFDM subcarrier is 312.5 KHz.

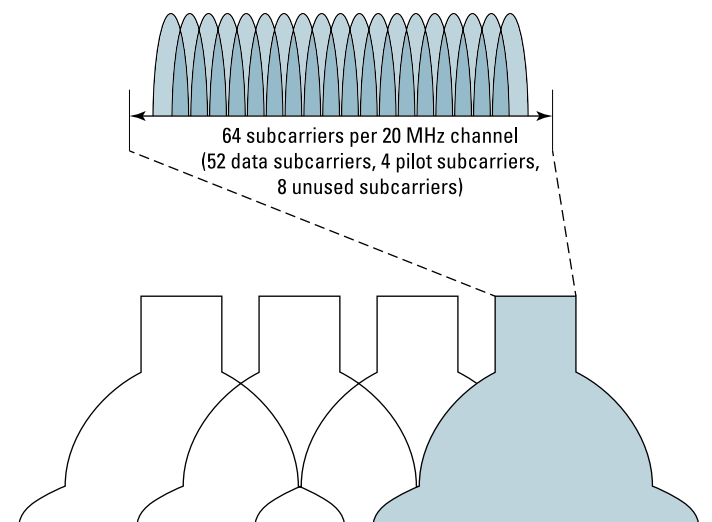

FIGURE 2-1: 802.11n/ac 20 MHz channel – OFDM subcarriers.

802.11ax introduces a longer OFDM symbol time of 12.8 microseconds, which is four times the legacy symbol time of 3.2 microseconds (for more information on symbol time, see Chapter 5). As a result of the longer symbol time, the subcarrier size and spacing decreases from 312.5 kHz to 78.125 kHz. The narrower subcarrier spacing allows better equalization and enhanced channel robustness. Because of the 78.125 kHz spacing, an OFDMA 20 MHz channel consists of a total of 256 subcarriers (tones) as depicted in Figure 2-2.

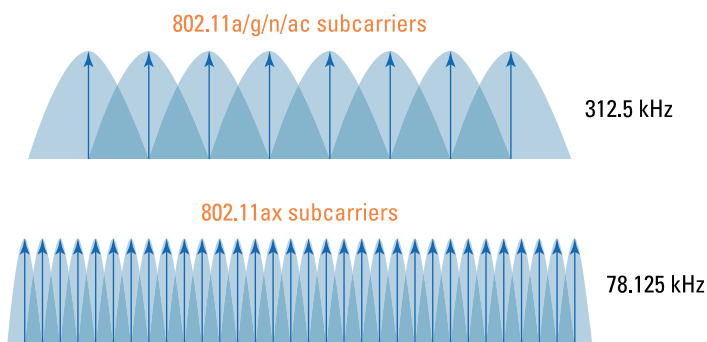

FIGURE 2-2: OFDM and OFDMA subcarrier spacing.



TECHNICAL
STUFF

Just like with OFDM, there are three types of subcarriers for OFDMA, as follows:

- » **Data subcarriers:** These subcarriers will use the same modulation and coding schemes (MCSs) as 802.11ac as well as two new MCSs with the addition of 1024 quadrature amplitude modulation (1024-QAM).
- » **Pilot subcarriers:** These subcarriers are used for synchronization between the transmitter and receiver and do not carry any modulated data.
- » **Unused subcarriers:** The remaining unused subcarriers are mainly used as guard carriers or null subcarriers against interference from adjacent channels or subchannels.

With OFDMA, these tones are grouped together into partitioned subchannels, known as resource units (RUs). By subdividing the channel, parallel transmissions of small frames to multiple users can happen simultaneously. The data and pilot subcarriers within each resource unit are both adjacent and contiguous within an OFDMA channel.



TIP

For backward compatibility, Wi-Fi 6 radios still support OFDM. Keep in mind that 802.11 management and control frames will still be transmitted at a basic data rate using OFDM technology that legacy 802.11a/g/n/ac radios can understand. Therefore management and control frames are transmitted across all the OFDM subcarriers of an entire primary 20 MHz channel. OFDMA is only for 802.11 data frame exchanges between Wi-Fi 6 APs and Wi-Fi 6 clients.

Resource Units (RUs)

To further illustrate the difference between OFDM and OFDMA, please reference Figures 2-3, 2-4 and 2-5. When an 802.11n/ac AP transmits downstream to 802.11n/ac clients on an OFDM channel, the entire frequency space of the channel is used for each independent downlink transmission. In the example shown in Figure 2-3 the AP transmits to six clients independently over time. When using a 20 MHz OFDM channel, all of the

64 subcarriers are used for each independent transmission. In other words, the entire 20 MHz channel is needed for the communication between the AP and a single OFDM client. The communications are single-user. The same holds true for any uplink transmission from a single 802.11n/ac client to the 802.11n/ac AP. The entire 20 MHz OFDM channel is needed for the client transmission to the AP.

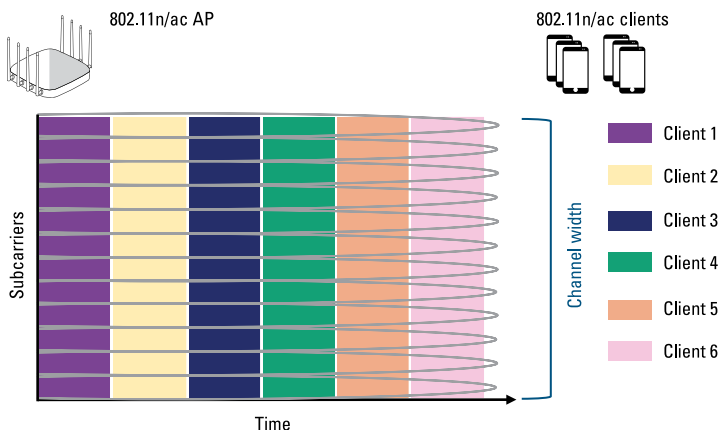

FIGURE 2-3: OFDM transmissions over time.

As previously stated, an OFDMA channel consists of a total of 256 subcarriers (tones). These tones can be grouped into smaller subchannels known as resource units (RUs). As shown in Figure 2-4, when subdividing a 20 MHz channel, a Wi-Fi 6 access point can designate 26, 52, 106, and 242 subcarrier resource units (RUs), which equates roughly to 2 MHz, 4 MHz, 8 MHz, and 20 MHz channels. The Wi-Fi 6 AP dictates how many RUs are used within a 20 MHz channel and different combinations can be used. The AP may allocate the whole channel to only one client at a time or it may partition the channel to serve multiple clients simultaneously. For example: A Wi-Fi 6 AP could simultaneously communicate with one Wi-Fi 6 client using 8 MHz of frequency space while communicating with three other Wi-Fi 6 clients using 4 MHz subchannels. These simultaneous communications can be either downlink or uplink.

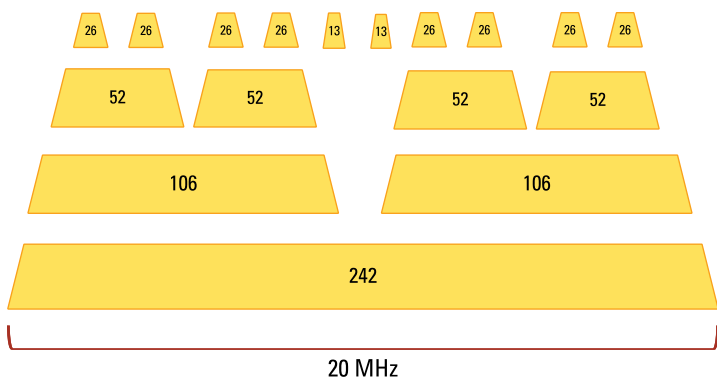

FIGURE 2-4: OFDM resource units – 20 MHz channel.

In the example shown in Figure 2-5, the Wi-Fi 6 AP first simultaneously transmits downlink to Wi-Fi 6 clients 1 and 2. The 20 MHz OFDMA channel is effectively partitioned into two sub-channels. Remember that an OFDMA 20 MHz channel has a total of 256 subcarriers; however, the AP is simultaneously transmitted to clients 1 and 2 using two different 106-tone resource units. In the second transmission, the AP simultaneously transmits downlink to clients 3, 4, 5, and 6. In this case, the OFDMA channel had to be partitioned into four different 52-tone resource units. In the third transmission, the AP uses a single 242-tone resource unit to transmit downlink to a single client (client 5). Using a single resource unit is effectively using the entire 20 MHz channel. In the fourth transmission, the AP simultaneously transmits downlink to clients 4 and 6 using two 106-tone resource units. In the fifth transmission, the AP once again only transmits downlink to a single client with a single RU utilizing the entire 20 MHz channel. In the sixth transmission, the AP simultaneously transmits downlink to clients 3, 4 and 6. In this instance, the 20 MHz channel is partitioned into three subchannels; two 52 RUs are used for clients 3 and 4 and a 106-tone RU for client 6.



It should be noted that the rules of medium contention still apply. The AP still has to compete against legacy clients for a transmission opportunity (TXOP). Once the AP has a TXOP, the AP is then in control of up to nine Wi-Fi 6 clients for either downlink or uplink transmissions. The number of RUs used can vary on a per-TXOP basis. OFDMA combines different user data within the 20 MHz channel. The AP assigns RUs to associated clients on a per-TXOP basis to maximize the download and upload efficiency.

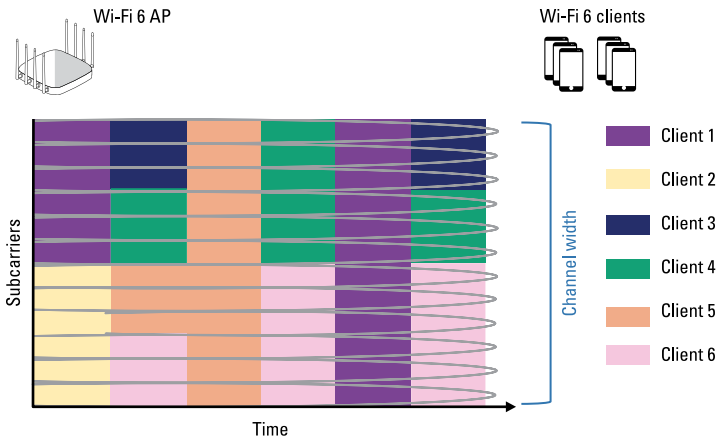

FIGURE 2-5: OFDMA transmissions over time.

In addition to 20 MHz channels, 40, 80, and even 160 MHz channels can also be partitioned into various combinations of RUs as shown in Table 2-1. For example, if an 80 MHz channel was subdivided using strictly 26 subcarrier RUs, 37 Wi-Fi 6 clients could theoretically communicate simultaneously using their OFDMA capabilities.

TABLE 2-1 Resource Units and Wide Channels

| Resource Units (RUs) | 20 MHz channel | 40 MHz channel | 80 MHz channel | 160 MHz channel | 80 + 80 MHz channel |
|----------------------|----------------|----------------|----------------|-----------------|---------------------|
| 996 (2x) subcarriers | n/a | n/a | n/a | 1 client | 1 client |
| 996 subcarriers | n/a | n/a | 1 client | 2 clients | 2 clients |
| 484 subcarriers | n/a | 1 client | 2 clients | 4 clients | 4 clients |
| 242 subcarriers | 1 client | 2 clients | 4 clients | 8 clients | 8 clients |
| 106 subcarriers | 2 clients | 4 clients | 8 clients | 16 clients | 16 clients |
| 52 subcarriers | 4 clients | 8 clients | 16 clients | 32 clients | 32 clients |
| 26 subcarriers | 9 clients | 18 clients | 37 clients | 74 clients | 74 clients |



REMEMBER

The Wi-Fi CERTIFIED 6 certification program from the Wi-Fi Alliance currently validates up to four resource units. Initially, most real-world Wi-Fi 6 deployments will likely use 20 MHz or 40 MHz channels with a maximum of four clients participating in multi-user OFDMA transmissions per TXOP. Resource unit allocation and scheduling mechanisms will likely become more precise in later generations of firmware. Remember, the whole point of OFDMA is to make use of smaller subchannels.

Trigger Frames

When referencing downlink and uplink OFDMA transmissions, the acronyms of DL-OFDMA and UL-OFDMA are often used. The following sections explain that a series of frame exchanges are used for both DL-OFDMA and UL-OFDMA. In both cases, trigger frames are needed to bring about the necessary frame exchanges for multi-user communications. For example, an AP uses trigger frames to allocate OFDMA RUs to Wi-Fi 6 clients.



TECHNICAL STUFF

RU allocation information is communicated to clients at both the PHY and MAC layers. At the Physical layer, RU allocation information can be found in the HE-SIG-B field of the PHY header of a trigger frame. The HE-SIG-B field is used to communicate RU assignments to clients. As shown in Figure 2-6, the HE-SIG-B field consists of two subfields: the common field and user-specific field. A subfield of the common field is used to indicate how a channel is partitioned into various RUs. For example, a 20 MHz channel might be subdivided into one 106-tone RU and four 26-tone RUs. The user-specific field comprises multiple-user fields that are used to communicate which users are assigned to each individual RU.

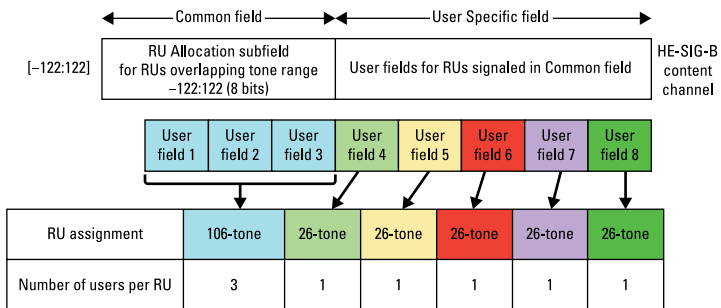

FIGURE 2-6: RU allocation at the PHY layer.

What about how RU allocation information is communicated at the MAC layer? RU allocation information is delivered in the user information field in the body of a trigger frame. Figure 2-7 displays a table of how RU allocation information is communicated at the MAC layer. The table highlights all the possible RUs within a 20 MHz channel and the subcarrier range for each RU. Each specific RU is defined by a unique combination of 7 bits within the user information field of the trigger frame, known as the RU allocation bits.

| 26 tone RU | RU-1 | RU-2 | RU-3 | RU-4 | RU-5 | RU-6 | RU-7 | RU-8 | RU-9 |
|--------------------|----------------|---------|---------|---------|--------------|---------|---------|---------|---------|
| Subcarrier range | -121:-96 | -95:-70 | -68:-43 | -42:-17 | -16:-4, 4:16 | 17:42 | 43:68 | 70:95 | 96:121 |
| RU allocation bits | 0000000 | 0000001 | 0000010 | 0000011 | 0000100 | 0000101 | 0000110 | 0000111 | 0001000 |
| | | | | | | | | | |
| 52 tone RU | RU-1 | | RU-2 | | RU-3 | | | RU-4 | |
| Subcarrier range | -121:-70 | | -68:-17 | | 17:68 | | | 70:121 | |
| RU allocation bits | 0100101 | | 0100110 | | 0100111 | | | 0101000 | |
| | | | | | | | | | |
| 106 tone RU | RU-1 | | | | RU-2 | | | | |
| Subcarrier range | -122:-17 | | | | 17:122 | | | | |
| RU allocation bits | 0110101 | | | | 0110110 | | | | |
| | | | | | | | | | |
| 242 tone RU | RU-1 | | | | | | | | |
| Subcarrier range | -122:-2, 2:122 | | | | | | | | |
| RU allocation bits | 0111101 | | | | | | | | |

FIGURE 2-7: RU allocation at the MAC layer.

In the example in Figure 2-8, the trigger frame allocates specific RUs to three client stations for simultaneous uplink transmission within a 20 MHz OFDMA channel. Clients STA-1 and STA-2 are each assigned to a 52-tone RU, whereas client STA-3 is assigned to a 106-tone RU.

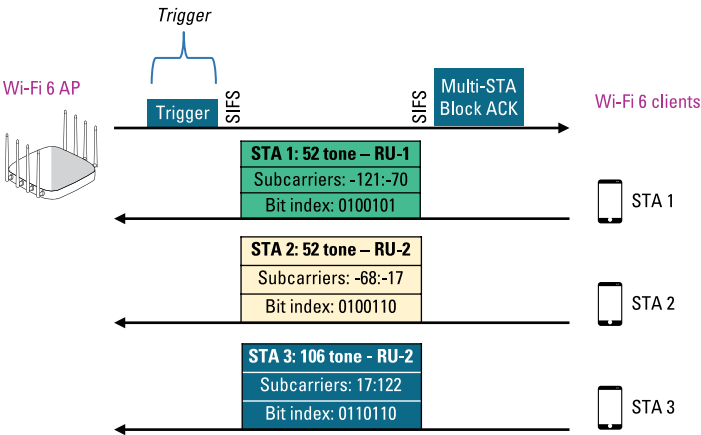

FIGURE 2-8: RU allocation with trigger frames.



For UL-OFDMA, a trigger frame sent by the AP is also used to tell the clients how many spatial streams and which modulation and coding scheme (MCS) to use when transmitting uplink on their assigned RUs. This information can be found in the SS Allocation and UL MCS subfields of the user information field within the body of a trigger frame. Trigger frames can also be used by an AP to tell clients to adjust their power settings for synchronized uplink transmissions. Within a trigger frame, the UL Target RSSI subfield indicates, in a dBm value, the expected receive power at the AP across all antennas for the assigned RU transmissions from the uplink clients. The UL Target RSSI subfield uses values of 0 to 90, which are directly mapped from -110 dBm to -20 dBm. A value of 127 indicates to the client station to transmit at its maximum power for the assigned MCS. Based on the information provided by the trigger frame, the transmit power could be adjusted by the uplink clients. Please note that a Wi-Fi 6 client might be unable to satisfy the target RSSI due to its hardware or regulatory limitations.

DL-OFDMA

Trigger frames can be used for multi-user DL-OFDMA communications between a Wi-Fi 6 AP and Wi-Fi 6 clients. A Wi-Fi 6 AP will first need to contend for the medium and win a TXOP for the entire DL-OFDMA frame exchange. As shown in Figure 2-9, once an AP has won a TXOP, the AP might send a multi-user request-to-send (MU-RTS) frame. The MU-RTS frame has two purposes:

- » **Reserve the medium:** The MU-RTS frame is transmitted using OFDM (not OFDMA) across the entire 20 MHz channel so that legacy clients can also understand the MU-RTS. The duration value of the MU-RTS frame is needed to reserve the medium and reset the NAV timers of all legacy clients for the remainder of the DL-OFDMA frame exchange. The legacy clients must remain idle while the multi-user OFDMA data frames are transmitted between the Wi-Fi 6 AP and Wi-Fi 6.

» **RU allocation:** The MU-RTS frame is also an extended trigger frame from the AP used to synchronize uplink clear-to-send (CTS) client responses for Wi-Fi 6 clients. The AP uses the MU-RTS as a trigger frame to allocate RUs. The Wi-Fi 6 clients will send CTS responses in parallel using their assigned RUs.

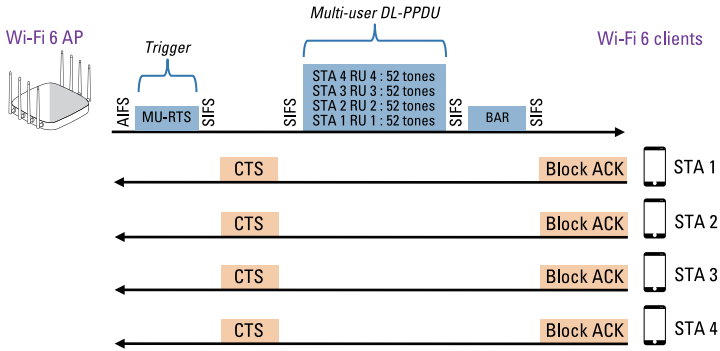

FIGURE 2-9: Downlink OFDMA.

After the parallel CTS response from the clients, the AP will begin multi-user DL-PPDU transmissions from the AP to the OFDMA-capable clients. Keep in mind that the AP determined how to partition the 20 MHz channel into multiple RUs. Once the Wi-Fi 6 clients receive their data via their assigned RUs, they will need to send a Block ACK to the AP. The AP will send a Block ACK request (BAR) frame followed by the clients replying with Block ACKs in parallel. Optionally, an automatic Block ACK can be sent by the clients in parallel.

Once the frame exchange is over, the AP or clients that win the next TXOP will then be able to transmit on the medium. Single-user communications can still occur for legacy clients. For example, if an 802.11n/ac client wins the next TXOP, the 802.11n/ac client will use an entire 20 MHz channel for an uplink transmission to the AP using OFDM.

UL-OFDMA

In the original 802.11 standard, the IEEE proposed an operational mode called *Point Coordination Function (PCF)*, which defined operations where the AP could control the medium for uplink client transmission. With PCF mode, the AP could poll clients for uplink transmissions during a contention-free period of time when the AP controlled the medium. However, PCF never caught on and was never implemented in the real world. 802.11ax now introduces mechanisms where the AP can once again control the medium for uplink transmissions using UL-OFDMA. You should understand that UL-OFDMA has nothing to do with PCF; the methods are very different. You should also understand that the 802.11ax AP must first contend for the medium and win a TXOP. Once the 802.11ax AP wins a TXOP, it can then coordinate uplink transmissions from 802.11ax clients that support UL-OFDMA.

UL-OFDMA is more complex than DL-OFDMA and may require the use of as many as three trigger frames. Each trigger frame is used to solicit a specific type of response from the Wi-Fi 6 clients. UL-OFDMA also requires the use of *buffer status report (BSR)* frames from the clients. Clients use BSR frames to inform the AP about the client's buffered data and about the QoS category of data. The information contained in BSR frames assists the AP in allocating RUs for synchronized uplink transmissions. The AP will use the information gathered from the clients to build uplink window times, client RU allocation, and client power settings for each RU. BSRs can be unsolicited or solicited. If solicited, the AP will poll the clients for BSRs.

As shown in Figure 2-10, once a Wi-Fi 6 AP has won a TXOP, the AP will send the first trigger frame. A buffer status report poll (BSRP) frame is used to solicit information from the Wi-Fi 6 clients about their need to send uplink data. The clients will then respond with BSRs. The whole purpose of the BSR information is so the Wi-Fi 6 clients can assist a Wi-Fi 6 AP to allocate uplink multi-user resources. The AP will use this information to decide how to best allocate RUs to the clients for synchronized uplink transmissions.

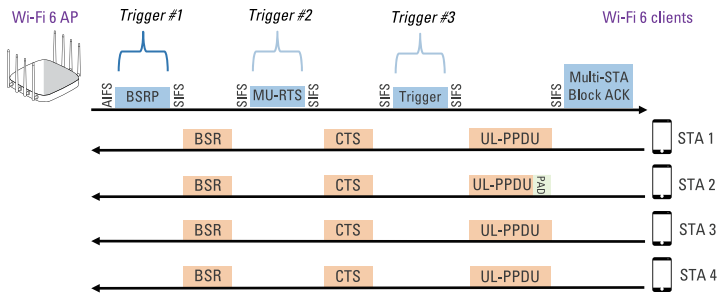

FIGURE 2-10: Uplink OFDMA.

If legacy clients exist, the AP may send a multi-user request-to-send (MU-RTS) frame, which functions as a second type of trigger frame. The RTS/CTS process is once again used to reserve the medium for OFDMA communications only.

A third and final basic trigger frame is needed to signal the Wi-Fi 6 clients to begin uplink transmission of their data with their assigned RUs. The basic trigger frame also dictates the length of the uplink window. The uplink client devices must all start and stop at the same time. The basic trigger frame also contains power control information so that individual clients can increase or decrease their transmit power. This will help equalize the received power to the AP from all uplink clients and improve reception. Once the uplink data is received from the clients, the AP will send a single multi-user Block ACK to the clients. The AP also has the option of sending separate Block ACKs to each individual client.

You should understand that all three trigger frames may or may not be needed for uplink transmission. For example, the MU-RTS trigger frame is only needed for protection mechanism purposes for legacy clients.

Buffer Status Reports

As previously stated, Wi-Fi 6 APs require specifics on client buffer states to perform appropriate synchronized uplink scheduling. As a result, the Wi-Fi 6 clients deliver BSRs to assist the AP in allocating uplink multi-user resources. Clients have two methods of

delivering their buffer state information to the AP. As previously discussed, clients can *explicitly* deliver BSRs to the AP in response to a BSRP trigger frame (solicited BSR). This method is illustrated in Figure 2-10. However this solicited polling process does generate overhead. To minimize overhead, an access point can include a BSRP trigger frame together with other control, data, and management frames in one A-MPDU sent to a client that supports the capability.

Clients can *implicitly* deliver BSRs in the QoS Control field or BSR Control field of any frame transmitted to the AP (unsolicited BSR). Wi-Fi 6 clients can report unsolicited buffer status information for any given QoS class of traffic in any QoS Data or QoS Null frames it transmits. Additionally, as depicted in Figure 2-11, a Wi-Fi 6 client can report the buffer status of multiple QoS access categories using A-MPDU frame aggregation of QoS Data or QoS Null frames. The unsolicited BSR process is more efficient because it eliminates the need for polling.

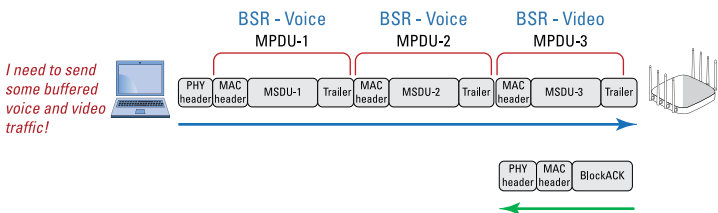

FIGURE 2-11: Unsolicited buffer status reports and A-MPDU.

In addition to the scheduled UL-OFDMA, 802.11ax also provides for an optional *UL-OFDMA random access (UORA)* method. A random-access method is favorable in conditions where the AP is unaware of traffic buffered on the clients. The AP sends a random-access trigger frame to allocate RUs for random access. Clients that want to transmit will use an *OFDMA back-off (OBO)* procedure. Initially, a client chooses a random value, with each trigger frame the client decrements the value by the number of RUs specified in the trigger frame until it reaches zero. The client will then randomly select an RU and then transmit.

OMI

For backward compatibility purposes, legacy 802.11a/b/g/n/ac Wi-Fi clients will still contend for the medium and win their own TXOP if they want to transmit uplink. However, the uplink transmissions of Wi-Fi 6 clients are synchronized and controlled by the access point. A question that I am often asked is, “Can a Wi-Fi 6 client station suspend participation for synchronized uplink OFDMA and contend for the medium for an independent uplink transmission?”

802.11ax defines an *operating mode indication (OMI)* procedure for this purpose. As shown in Figure 2-12, the Wi-Fi 6 client that transmits a frame with an OM Control subfield is defined as the OMI initiator and the AP is the OMI responder. A Wi-Fi 6 client uses the OM Control subfield in 802.11 data and management frames to indicate a change of either transmission or receiver mode of operation.

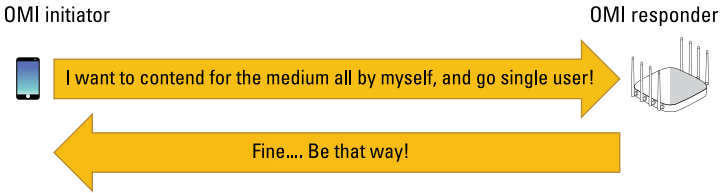

FIGURE 2-12: Transmit Operating Mode.

A client can switch between single-user or multi-user UL-OFDMA operations with a change in transmit operating mode (TOM). Therefore, a Wi-Fi 6 client can both suspend and resume responses to the trigger frames sent by an AP during the UL-OFDMA process.

Additionally, a Wi-Fi client station can signal a change in receive operating mode (ROM) to the AP. The client indicates to the AP the maximum number of spatial streams and the maximum channel bandwidth that the client can support for downlink transmission. As shown in Figure 2-13, the client can indicate a change in channel size and number of supported spatial steams.

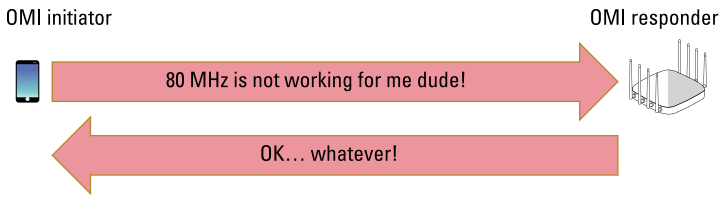

FIGURE 2-13: Receive Operating Mode.

You might surmise that OFDMA requires a lot of complex math and you would be correct. Another question that I get all the time is “Are there any defined standards on how a Wi-Fi 6 AP makes the decisions on how to allocate the RUs to multiple clients?” The answer is no, and a lot of the RU allocation horsepower will depend on the radio chipset vendors. WLAN vendors may then further enhance their own airtime scheduling capabilities for RU allocation. As previously mentioned, RU allocation and scheduling mechanisms will likely become more precise in later generations of firmware.

802.11n/ac APs cannot be upgraded to perform OFDMA operations. 802.11ax APs will also require more processor power to perform the calculations needed for OFDMA operations. OFDMA is truly the secret sauce of Wi-Fi 6 that promises true multi-user communication.

IN THIS CHAPTER

- » Understanding MU-MIMO technology
- » Recognizing spatial diversity requirements
- » Applying MU-MIMO in the real world: PtMP bridging
- » Differentiating between MU-OFDMA and MU-MIMO

Chapter 3

Multi-User Technology #2: MU-MIMO

In this chapter, you learn about the other Wi-Fi 6 multi-user technology, MU-MIMO.

Introducing MU-MIMO

Wi-Fi 6 radios also support a secondary multi-user technology called multiple-input multiple-output (MU-MIMO). Much like OFDMA, MU-MIMO allows for multiple user communications downlink from an access point (AP) to multiple clients during the same transmission opportunity (TXOP). However, as opposed to partitioning the frequency space, MU-MIMO instead takes advantage of the fact that APs have multiple radios and antennas. A MU-MIMO access point transmits unique modulated data streams to multiple clients simultaneously (see Figure 3-1). The goal is to improve efficiency by using less airtime.

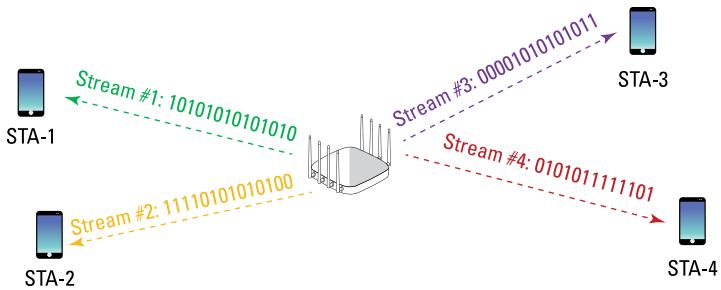

FIGURE 3-1: MU-MIMO – multi-user multiple-input multiple-output.



A five-number syntax is sometimes used when describing MU-MIMO radio capabilities. In a MU-MIMO system, the first number always references the transmitters (TX), and the second number references the receivers (RX). The third number represents how many unique single-user (SU) streams of data can be sent or received. The fourth number references how many multiple-user (MU) streams can be transmitted. A fifth number is used to represent a MU-MIMO group or how many MU-MIMO clients are receiving transmissions at the same time.

For example, when a MU-MIMO-capable AP operates using $4 \times 4 : 4 : 4 : 4$, four unique spatial streams would be destined to four independent MU-MIMO-capable clients (see Figure 3-1). However, when a MU-MIMO-capable AP operates as a $4 \times 4 : 4 : 4 : 2$ MU-MIMO AP, two unique spatial streams would be destined to one $2 \times 2 : 2$ client and the other two spatial streams would be destined for a different $2 \times 2 : 2$ client (see Figure 3-2).

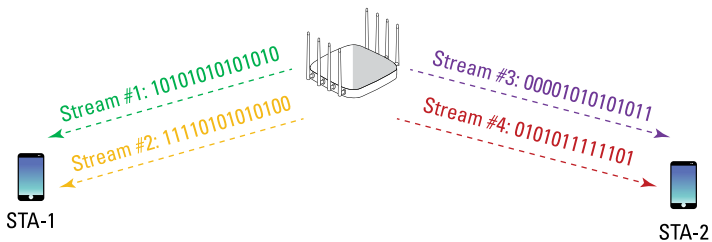

FIGURE 3-2: Downlink MU-MIMO – $4 \times 4 : 4 : 4 : 2$.

So how would this work if there are 20 MU-MIMO clients associated to the Wi-Fi 6 AP? The AP makes the decision as to which clients received the downlink MU-MIMO transmissions and which clients are assigned to the MU-MIMO client group. For example, four clients could receive spatial streams simultaneously in the

first downlink transmission and then four different clients might receive spatial streams simultaneously in the next downlink transmission.

Downlink MU-MIMO was first introduced in the second generation of 802.11ac radios. However, very few MU-MIMO-capable 802.11ac (Wi-Fi 5) clients currently exist in the marketplace, and the technology has rarely been used in the enterprise. Figure 3-3 displays the *maximum client capabilities* view within the ExtremeCloud IQ management platform. In this example, less than 10 percent of the clients support MU-MIMO.

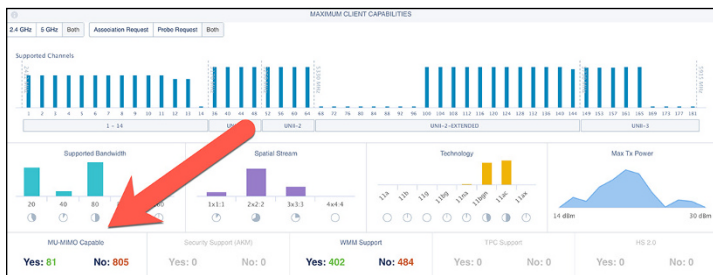

FIGURE 3-3: Maximum client capabilities.

A key difference between Wi-Fi 5 (802.11ac) MU-MIMO and Wi-Fi 6 MU-MIMO is how many MU-MIMO clients communicate with an AP at the same time. Wi-Fi 5 is limited to a MU-MIMO group of only four clients. Wi-Fi 6 is designed to support up to 8x8:8 MU-MIMO in both downlink and uplink, which allows it to serve up to eight users simultaneously and provide significantly higher data throughput.



REMEMBER

Downlink MU-MIMO will be available in Wi-Fi 6 radios. Support for uplink MU-MIMO will not be available in the first generation of Wi-Fi 6 radios.

I Need Some Space

Wi-Fi 6 clients support downlink MU-MIMO; however, MU-MIMO requires spatial diversity. Because of this, physical distance between the clients is necessary (See Figure 3-4). Even if all Wi-Fi clients support MU-MIMO, the majority of modern-day enterprise deployments of Wi-Fi involve a high density of users and devices that is not conducive for MU-MIMO conditions.

MU-MIMO requires sizable physical distance between the clients, as well as the AP, for spatial diversity, which may limit its usefulness.

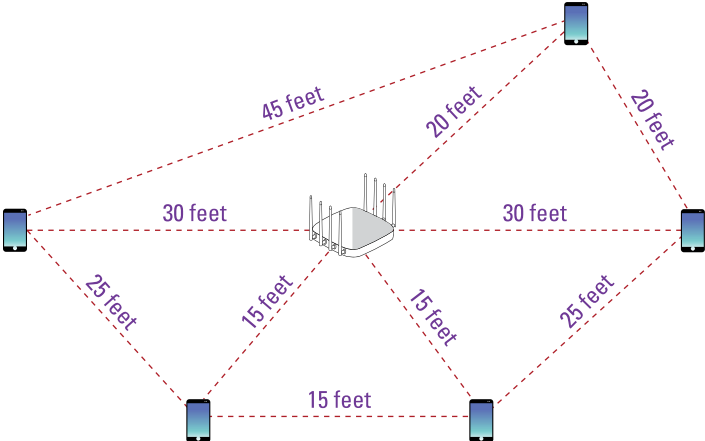

FIGURE 3-4: Spatial diversity – MU-MIMO.

Almost all indoor WLANs are high-density (HD) environments because there are so many users and so many devices. Many of the users want to connect to an enterprise WLAN with as many as three or four Wi-Fi devices. Most high-density environments consist of multiple areas where roaming is also a top priority. The required spatial diversity simply does not exist within the bulk of indoor enterprise Wi-Fi high-density deployments as depicted in Figure 3-5.

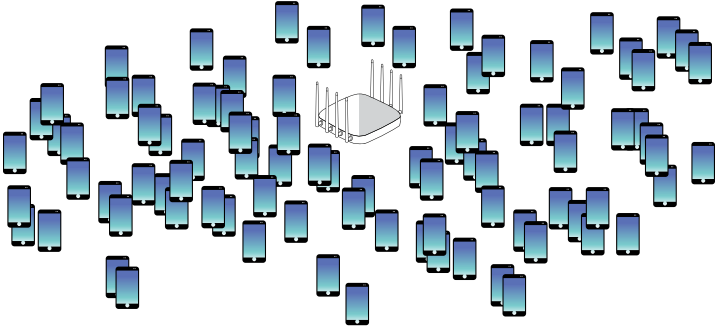

FIGURE 3-5: High-density enterprise Wi-Fi deployment.

Bridge over Troubled Waters

A very good use case for MU-MIMO is point-to-multipoint (PtMP) bridge links between buildings (see Figure 3-6). The spatial diversity that is required for MU-MIMO exists in this type of outdoor deployment. Bridge links require high bandwidth, which MU-MIMO can deliver with a PtMP deployment.

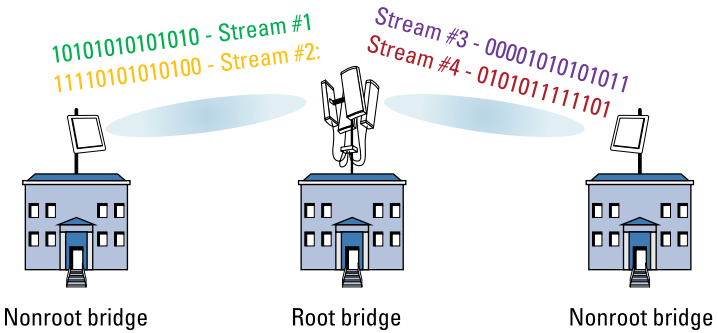

FIGURE 3-6: Point-to-multipoint (PtMP) bridge links.

What Is the Difference?

In the previous chapters, I discuss two separate multi-user technologies that Wi-Fi 6 has to offer. So how do they compare? Table 3-1 compares MU-OFDMA and MU-MIMO.

TABLE 3-1 MU-OFDMA and MU-MIMO Comparison

| MU-OFDMA | MU-MIMO |
|-------------------------------------|--------------------------------------|
| Increased efficiency | Increased capacity |
| Reduced latency | Higher data rates per user |
| Best for low-bandwidth applications | Best for high-bandwidth applications |
| Best with small packets | Best with large packets |

MU-MIMO would theoretically be a favorable option in very low client density, high-bandwidth application environments where large packets are transmitted.



TECHNICAL
STUFF

The minimum RU size for MU-MIMO (downlink or uplink) is 106 subcarriers or greater.

Wi-Fi allows for simultaneous use of both MU-OFDMA and MU-MIMO, but this is not expected to be widely implemented.



REMEMBER

Do not confuse OFDMA with MU-MIMO. OFDMA enables multi-user access by subdividing a channel. MU-MIMO enables multi-user access by using different spatial streams.

IN THIS CHAPTER

- » Understanding medium contention overhead
- » Recognizing the cause of OBSS
- » Differentiating between basic service sets
- » Applying adaptive CCA thresholds

Chapter 4

BSS Color and Spatial Reuse

In this chapter, you learn about BSS color and spatial reuse operation, which have the potential to decrease medium contention overhead.

OBSS

Wi-Fi uses radio frequency communication, which is a half-duplex medium — where only one radio can transmit on a frequency domain at any given time. A frequency domain is a fancy technical phrase for a channel. Everyone must take turns because if everyone “talks” at the same time, no data is communicated because no one is “listening.”



REMEMBER

Carrier sense with multiple access collision avoidance (CSMA/CA) is the method used in Wi-Fi networks to ensure that only one radio can transmit on the same channel at any given time. An 802.11 radio will defer transmissions if it hears the physical (PHY) preamble transmissions of any other 802.11 radio at a *signal detect (SD)* threshold of just four decibels or more above the noise floor. CSMA/CA is necessary to avoid collisions; however, the deferral of transmissions also consumes valuable airtime. This problem is

referred to as *contention overhead*. Unnecessary medium contention overhead that occurs when too many APs and clients hear each other on the same channel is called an *overlapping basic service set (OBSS)*, shown in Figure 4-1. OBSS is also more commonly referred to as *co-channel interference*.

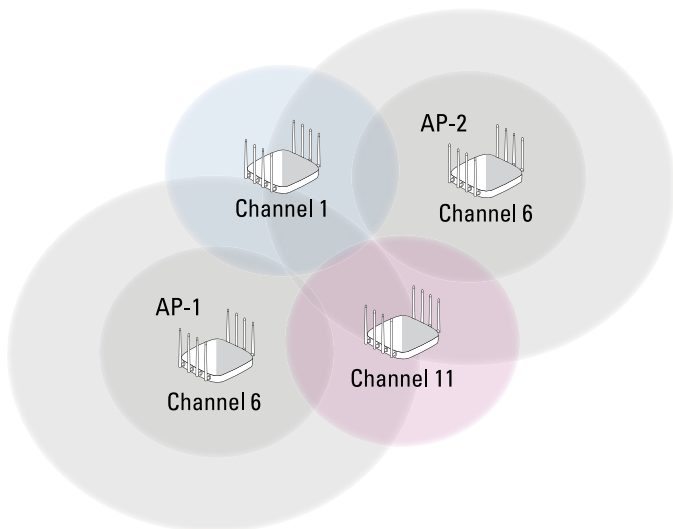

FIGURE 4-1: OBSS – Overlapping basic service set.

For example, if AP-1 on channel 6 hears the preamble transmission of a nearby AP (AP-2), also transmitting on channel 6, AP-1 will defer and can't transmit at the same time. Likewise, all the clients associated to AP-1 must also defer transmission if they hear the preamble transmission of AP-2. The basic service set (BSS) is the cornerstone topology of Wi-Fi network. The communicating devices that make up a BSS consist of one AP radio with one or more client stations. OBSS creates medium contention overhead and consumes valuable airtime because you have two basic service sets on the same channel that can hear each other — thus, the term OBSS.

In reality, Wi-Fi clients are the primary cause of OBSS interference. As shown in Figure 4-2, if a client associated to AP-2 is transmitting on channel 36, it is possible that AP-1 (and any clients associated to AP-1) will hear the PHY preamble of the client and must defer any transmissions.

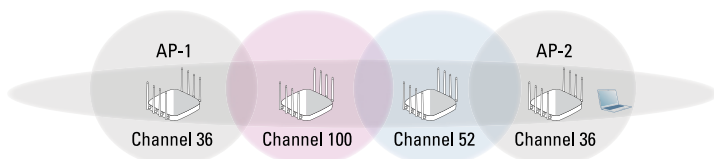

FIGURE 4-2: OBSS interference caused by client.



REMEMBER

Due to the mobile nature of Wi-Fi client devices, OBSS interference isn't static: It changes as client devices move.

The primary goal of channel reuse patterns is to reduce co-channel interference (also known as OBSS). A channel reuse plan reduces airtime consumption caused by OBSS by isolating frequency domains. However, only three channels are used in the 2.4 GHz band. Because only three channels are available in the 2.4 GHz band and because OBSS is caused by clients, medium contention deferral is pretty much inevitable in the 2.4 GHz band. OBSS also is a problem in the 5 GHz band, especially if many of the 5 GHz channels are not available for a 5 GHz channel reuse plan. To increase capacity in dense environments, frequency reuse between basic service sets needs to be increased.

BSS Color

The IEEE 802.11ax standard defines a method that may increase the channel reuse by a factor of eight. *BSS color*, also known as BSS coloring, is a method for addressing medium contention overhead due to OBSS. BSS color is an identifier of the basic service set (BSS). In reality, the BSS color identifier is not a color, but instead is a numerical identifier. Wi-Fi 6 radios are able to differentiate between BSSs using a BSS color (numerical identifier) when other radios transmit on the same channel.



TECHNICAL
STUFF

BSS color information is communicated at both the PHY layer and the MAC sublayer. In the preamble of an 802.11ax PHY header, the SIG-A field contains a 6-bit BSS color field. This field can identify as many as 63 BSSs. At the MAC sublayer, BSS color information is seen in 802.11 management frames. The HE operation information element contains a subfield for BSS color information. Six bits

can be used to identify as many as 63 different colors (numerical values) and represent 63 different BSSs. The goal is for Wi-Fi 6 radios to differentiate between BSSs using a BSS color identifier when other radios transmit on the same channel.



REMEMBER

BSS color detects a color bit in the PHY header of a Wi-Fi 6 radio frame transmission. This means that legacy 802.11a/b/g/n radios will not be able to interpret the color bits because they use a different PHY header format.

When a Wi-Fi 6 radio is listening to the medium and hears the PHY header of an 802.11ax frame sent by another Wi-Fi 6 radio, the listening radio will check the BSS color of the transmitting radio. Channel access is dependent on the color detected:

- » If the color is the same, then the frame is considered an *intra-BSS* transmission and the listening radio will defer. If the color is the same, this is considered to be an intra-BSS frame transmission. In other words, the transmitting radio belongs to the same BSS as the receiver; therefore, the listening radio will defer.
- » If the color is different, then the frame is considered an *inter-BSS* transmission from an OBSS and deferral may not be necessary for the listening radio.

Spatial Reuse Operation

Using a procedure called *spatial reuse operation (SRO)*, Wi-Fi 6 radios will be able to apply adaptive clear channel assessment (CCA) thresholds for detected OBSS frame transmissions. The goal of BSS color and spatial reuse is to ignore transmissions from an OBSS and therefore be able to transmit at the same time. In the example shown in Figure 4-3, any radio on channel 36 that detected the red color would defer because that would be considered an intra-BSS. However, deferral may not be necessary if an AP detected a green or blue color from nearby OBSS transmissions also on channel 36. Keep in mind that this figure is a visual illustration and that the color information is actually a numerical value.

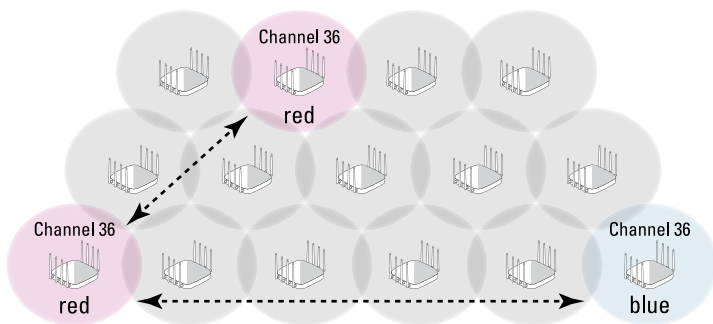

FIGURE 4-3: BSS color.

Based on the detected BSS color, Wi-Fi 6 radios can implement an adaptive CCA implementation that can raise the signal detect threshold for inter-BSS frames while maintaining a lower threshold for intra-BSS traffic. If the signal detect threshold is raised higher for incoming OBSS frames, a radio might not need to defer, despite being on the same channel. The adaptive signal detect threshold can be adjusted on a per-color and per-frame basis for inter-BSS traffic. In the example in Figure 4-4, an SD threshold of -96 dBm (decibels relative to 1 milliwatt) might be used for the reception of intra-BSS traffic, while an adaptive SD threshold between -96 dBm to -83 dBm might be used for inter-BSS traffic.

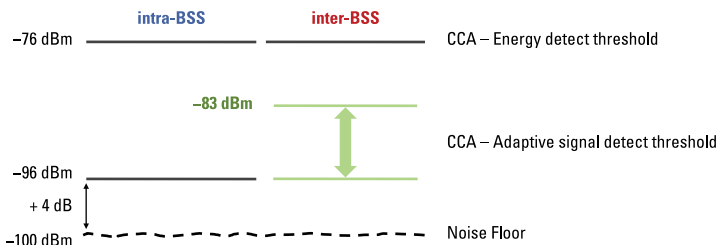

FIGURE 4-4: Spatial reuse operation - Adaptive CCA

BSS color together with spatial reuse operation have the potential to decrease the OBSS channel contention problem that is symptomatic of existing low SD thresholds.

IN THIS CHAPTER

- » Conserving power with TWT
- » Achieving higher data speeds with 1024-QAM
- » Defining new PHY headers
- » Utilizing 20 MHz-only mode

Chapter 5

Additional Wi-Fi 6 Enhancements

In this chapter, you learn about several other Wi-Fi 6 enhancements including target wake time (TWT), 1024 quadrature amplitude modulation (1024-QAM), and new frame formats, as well as other Wi-Fi 6 efficiency mechanisms.

Target Wake Time (TWT)

Target wake time (TWT) is a Wi-Fi 6 enhanced power-saving mechanism. A TWT is a negotiated agreement, based on expected traffic activity between the access point (AP) and clients, to specify a scheduled target wake-up time for Wi-Fi 6 clients in power-save (PS) mode. The negotiated TWTs allow an AP to manage client activity by scheduling client stations to operate at different times in order to minimize contention between the clients. A TWT reduces the required amount of time that a client station in PS mode needs to be awake.



REMEMBER

This allows the client to “sleep” longer and reduce energy consumption. As opposed to legacy client power-saving mechanisms such as delivery traffic indication map (DTIM), which require sleeping client devices to wake up in microsecond intervals, TWT could theoretically allow client devices to sleep for hours. TWT is thus an ideal power-saving method for mobile devices and Internet of Things (IoT) devices that need to conserve battery life.

As depicted in Figure 5-1, a TWT frame exchange is used between the AP and the clients to negotiate a scheduled TWT. For each Wi-Fi 6 client there can be as many as eight separate negotiated scheduled wake-up agreements for different types of application traffic. Once the negotiation is complete, the clients sleep and then awoken at the targeted intervals.

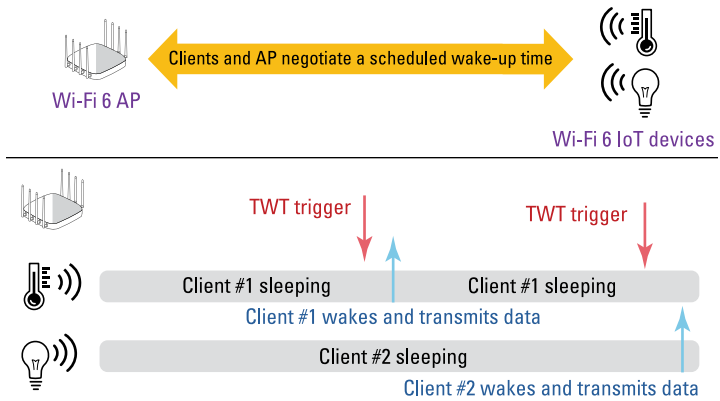

FIGURE 5-1: Target wake time.



TIP

Most IoT devices with a Wi-Fi radio transmit in the 2.4 GHz frequency band. Keep your fingers crossed for IoT device manufacturers to take advantage of Wi-Fi 6 radios in their IoT devices as opposed to other communication technologies such as Bluetooth Low Energy (BLE), Sigfox, and Zigbee.

1024-QAM

Although the primary goal of Wi-Fi 6 is increased efficiency, more speed is not a bad thing. Elevated efficiency and more speed are not mutually exclusive goals. *Quadrature amplitude modulation (QAM)*

uses both the phase and amplitude of a radio frequency signal to represent data bits. Wi-Fi will support 1024-QAM and new modulation and coding schemes (MCSs) that define higher data rates.



For comparison, 256-QAM (introduced in 802.11ac) modulates 8 bits per symbol, whereas 1024-QAM modulates 10 bits per symbol — a potential 25 percent increase in data throughput. Wi-Fi 6 also introduces two new MCSs that make use of 1024-QAM modulation: MCS-10 and MCS-11, both of which will be optional. In first generation Wi-Fi 6 radios, 1024-QAM may only be used with 242-subcarrier resource units (RUs) or larger. This means that at least a full 20 MHz of channel bandwidth will be needed for 1024-QAM.

Much like 256-QAM, very high signal-to-noise ratio (SNR) thresholds (35 decibels or more) will be needed in order for Wi-Fi 6 radios to use 1024-QAM modulation. Pristine radio frequency environments with a low noise floor and close proximity between a Wi-Fi 6 client and a Wi-Fi 6 AP will most likely be needed.

A constellation diagram, also known as a *constellation map*, is a two-dimensional diagram often used to represent QAM modulation. A constellation diagram is divided into four quadrants, and different locations in each quadrant can be used to represent data bits. Areas on the quadrant relative to the horizontal axis can be used to represent various phase shifts. Areas relative to the vertical axis are used to represent amplitude shifts.

The number of points in the modulation constellation chart determines the number of bits conveyed with each symbol. Figure 5-2 shows a comparison of constellation charts between 256-QAM and 1024-QAM modulation. As you can see, 1024-QAM has many more constellation points. *Error vector magnitude (EVM)* is a measure used to quantify the performance of a radio receiver or transmitter in regard to modulation accuracy. With QAM modulation, EVM is a measure of how far a received signal is from a constellation point. Any Wi-Fi 6 radios that use 1024-QAM modulation will need strong EVM and receive sensitivity capabilities.

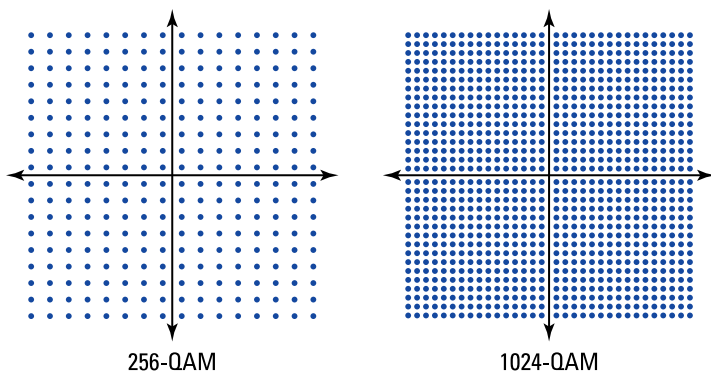

FIGURE 5-2: 256- and 1024-QAM.

Long Symbol Time and Guard Intervals

For digital signals, data is modulated onto the carrier signal in bits or collections of bits called *symbols*. 802.11ax introduces a longer OFDM symbol time of 12.8 μs (microseconds), which is four times the legacy symbol time of 3.2 μs . The increase in the number of subcarriers (tones) also increases the OFDM symbol duration. Subcarrier spacing is equal to the reciprocal of the symbol time. The symbol time used is four times longer, as 802.11ax uses subcarrier spacing of 78.125 KHz, which is one quarter the size of legacy 802.11n/ac subcarrier spacing.

The *guard interval* (GI) is a period of time between symbols that accommodates the late arrival of symbols over long paths. In a multipath environment, symbols travel different paths, so some symbols arrive later. A “new” symbol may arrive at a receiver before a “late” symbol has been completely received. This is known as *intersymbol interference* (ISI) and can result in data corruption. The *delay spread* is the time differential between multiple paths of the same signal. Normal delay spread is from 50 nanoseconds to 100 nanoseconds, and a maximum delay spread is about 200 nanoseconds. The guard interval should be two to four times the length of the delay spread. Think of the guard interval as a buffer for the delay spread.

802.11a/g defined the use of a 0.8 μs (which equals 800 nanoseconds) guard interval, while 802.11n/ac also added the option for a 0.4 μs (400 nanosecond) short guard interval, which was intended for use in indoor environments. When the legacy symbol time of

3.2 μs , which is used for the modulated data, is combined with the standard 0.8 μs guard interval, the total symbol duration is 4.0 μs . When the legacy data symbol time of 3.2 μs is combined with the 0.4 μs short guard interval, the total symbol duration is 3.6 μs .

Wi-Fi 6 radios utilize three different guard intervals that can be used together with the 12.8 μs symbol time that is used for the modulated data:

- » **0.8 μs Guard Interval:** This guard interval is likely to be used for most indoor environments. When combined with the time of 12.8 μs that is used for the data, the total symbol time for indoor communications will be 13.6 μs .
- » **1.6 μs Guard Interval:** This guard interval is intended for outdoor communications. When combined with the time of 12.8 μs that is used for the data, the total symbol time will be 14.4 μs . The guard interval may be needed in high multipath indoor environments to ensure the stability of uplink MU-OFDMA or uplink MU-MIMO communication.
- » **3.2 μs Guard Interval:** This guard interval is also intended for outdoor communications. When combined with the time of 12.8 μs that is used for the data, the total symbol time will be 16.0 μs . The longer symbol time and longer guard intervals will provide for more robust outdoor communications.

New PHY Headers

Added to all 802.11 frames is a physical (PHY) header that contains a preamble and other information used for initial setup of communications between two radios. As shown in Figure 5-3, Wi-Fi 6 radios make use of four new PHY headers to support high efficiency (HE) radio transmission, as follows:

- » **HE SU:** The high efficiency single-user PHY header is used for single-user transmissions.
- » **HE MU:** The high efficiency multi-user PHY header is used for transmissions to one or more users. This format is not used as a response to a trigger, which means this PHY header is used for trigger frames or downlink transmissions.

- » **HE ER SU:** The high efficiency extended-range single-user format is intended for a single user. Portions of this PHY header are boosted by 3 decibels to enhance outdoor communications and range.
- » **HE TB:** The high efficiency trigger-based format is for a transmission that is a response to a trigger frame. In other words, this PHY header format is used for uplink communications.

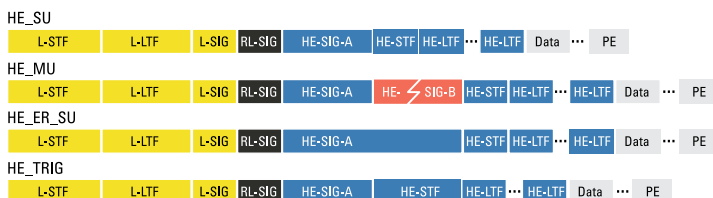

FIGURE 5-3: Wi-Fi 6 – PHY header formats



TECHNICAL
STUFF

The preamble is used for synchronization between transmitting and receiving radios and consists of two parts: legacy and high efficiency (HE). The legacy preamble is easily decodable by legacy stations (STAs) and is included for backward compatibility. The HE preamble components are used to communicate information between Wi-Fi 6 radios about OFDMA, MU-MIMO, BSS color, and more.

20 MHz-Only Mode

Some Wi-Fi 6 client radios can take advantage of a *20 MHz-only* mode of operation. Client stations will be able to inform an AP that they are operating as 20 MHz-only clients. As shown in Figure 5-4, a 20 MHz-only client can still operate within a 40 MHz or 80 MHz channel. However, the 20 MHz-only clients must communicate via RUs of the *primary channel*.



TECHNICAL
STUFF

What this effectively means is that the clients can support only certain tone mappings for OFDMA resource units. If the AP is transmitting on a standard 20 MHz channel, the 20 MHz-only client will obviously be able to support OFDMA tone mappings of a 26-tone RU, a 52-tone RU, a 106-tone RU, and a 242-tone RU within a 20 MHz channel. If the AP is transmitting on a 40 MHz channel, the 20 MHz-only client will be able to support only the

40 MHz tone mappings of a 26-tone RU, a 52-tone RU, or a 106-tone RU within the *primary channel*. Very specific 26-tone RU, 52-tone RU, or 106-tone mappings are also supported for a 20 MHz-only client, if the AP is transmitting on an 80 MHz channel or a 160 MHz channel.

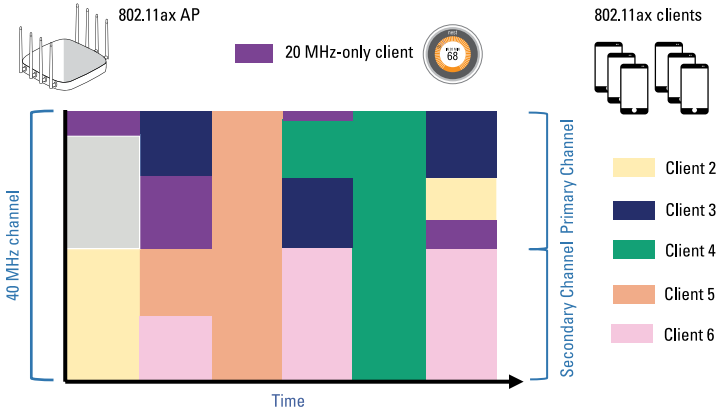

FIGURE 5-4: 20 MHz-only Wi-Fi 6 Client

The whole purpose behind these rules is to ensure that a 20 MHz-only client is only assigned the proper OFDMA tone mappings and RU allocations that the client can support even if larger channels are being used. As opposed to a smartphone or laptop client device, 20 MHz-only clients will be small form factor devices with limited processing capability and lower power requirements. The 20 MHz-only operational mode is ideal for IoT clients that could take advantage of the Wi-Fi 6 power-saving capabilities but not necessarily need the full capabilities that Wi-Fi 6 has to offer. This will allow client manufacturers to design less complex chipsets at a lower cost, which is ideal for IoT devices.

Multi-TID AMPDU

Two terms that everyone should understand are MSDU and MPDU. An 802.11 MAC Service Data Unit (MSDU) is the layer 3–7 payload of an 802.11 data frame. An 802.11 MAC Protocol Data Unit (MPDU) is essentially a technical term for a wireless frame. An MPDU consists of a frame header, body, and trailer with the MSDU payload encapsulated in the frame body.

Frame aggregation is a method of combining multiple frames into a single frame transmission. Fixed MAC layer overhead and medium contention overhead are reduced, which results in less airtime consumption. The most common method of frame aggregation is known as *aggregate MAC protocol data unit (A-MPDU)*. Multiple MPDUs can be aggregated into a single transmission. A-MPDU comprises multiple MPDUs and is prepended with a PHY header.

Prior to Wi-Fi 6, all the individual MPDUs must have been of the same 802.11e QoS access category when A-MPDU frame aggregation is used. Voice MPDUs cannot be mixed with Best Effort or Video MPDUs within the same aggregated frame.

As shown in Figure 5-5, Wi-Fi 6 introduces *multi-traffic identifier aggregated MAC protocol data unit (multi-TID AMPDU)*, which allows the aggregation of frames from multiple traffic identifiers (TIDs), from the same or different QoS access categories. The capability to mix MPDUs of different QoS traffic classes allows Wi-Fi 6 radios to aggregate more efficiently, reducing overhead and thus increasing throughput and therefore overall network efficiency.

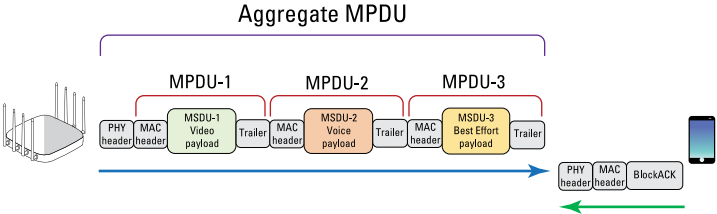

FIGURE 5-5: Multi-TID AMPDU.

- » Understanding Wi-Fi 6 client capabilities
- » Achieving MultiGig wired speeds
- » Providing Power over Ethernet
- » Debating 4x4:4 versus 8x8:8

Chapter 6

Wi-Fi 6 Key Questions

In this chapter, you learn about several of the most commonly asked questions in regard to Wi-Fi 6 and 802.11ax.

Clients

Surprisingly, I am often asked, “Will there be any 8x8:8 Wi-Fi 6 clients?” Most Wi-Fi mobile client devices such as smartphones will use dual-frequency 2x2:2 radios because an 8x8:8 radio would drain battery life. In the future, you might see some 4x4:4 client radios in high-end laptops.

The other big question that I get all the time is, “Will there be any performance benefit for legacy clients when Wi-Fi 6 APs (access points) are deployed?” The answer is yes and no. First the bad news. Legacy 802.11n/ac clients do not support Wi-Fi 6 mechanisms such as OFDMA. Therefore, the legacy clients will continue to use single-user communications when connected to a Wi-Fi 6 AP. Wi-Fi 6 clients are needed to take full advantage of 802.11ax high efficiency capabilities such as multi-user OFDMA. However, there is still good news for the legacy clients for two reasons:

- » **AP hardware:** Although there will be no physical (PHY) layer improvements with legacy clients, there will be performance improvements as a result of newer hardware capabilities of

the new Wi-Fi 6 APs, such as stronger CPUs and better memory handling.

- » **Airtime availability:** As more Wi-Fi 6 clients are mixed into the client population, the efficiency improvements gained by Wi-Fi 6 client devices will free valuable airtime for the legacy clients, therefore improving the overall efficiency of the wireless network.

The final client question that I am also asked is, “Where are the Wi-Fi 6 clients and how fast will we see them in the enterprise?” The answer is that Wi-Fi 6 clients have already entered the marketplace and a Wi-Fi 6 client population explosion already has begun. All the major chipset vendors such as Broadcom, Qualcomm, and Intel are manufacturing 2x2:2 Wi-Fi 6 radios that will find their way into smartphones, tablets, and laptops. Samsung released the Galaxy S10, the first Wi-Fi 6 smartphone, into the market in February of 2019. The Apple iPhones introduced in September 2019 also utilize Wi-Fi 6 radios. Industry analysts all agree that the Wi-Fi 6 technology growth will be fast and furious. For example, several research firms are predicting 1 billion Wi-Fi 6 chipsets will ship annually by 2022.

MultiGig

“Will MultiGig Ethernet be a necessity?” With each new generation of Wi-Fi technology and higher data rates, various bandwidth claims have been made in regard to the wired uplink connection between an AP and an access switch. Because Wi-Fi data rates have risen dramatically, the worrisome claims are that a standard 1 Gbps (gigabits per second) wired uplink will become a bottleneck. Take a look at this historically:

- » **802.11n:** Claims were made in 2009 that we were going to need aggregate GbE ports with two cables when 802.11n debuted. Did not happen.
- » **802.11ac:** Claims were made in 2013 that we were going to need aggregate GbE ports with two cables when 802.11ac debuted. Did not happen.
- » **802.11ac - Wave 2:** When the second generation of 802.11ac chipsets debuted in 2016, several enterprise switch vendors

made claims that everyone needed to upgrade their switches to support 2.5 GbE uplinks with 802.3bz MultiGig technology. Did not happen.

Prior to Wi-Fi 6 (802.11ax), the only time a 1 Gbps uplink has not been sufficient is in laboratory test environments or very unique corner cases. Bandwidth bottlenecks almost never occur at the access layer. However, bandwidth bottlenecks can certainly occur on the wired network due to poor wired network design. The number one bandwidth bottleneck is usually the WAN uplink at any remote site. But it is safe to say that the Wi-Fi will always be blamed first despite the inadequate WAN bandwidth.



As shown in Figure 6-1, the 802.3bz standard (also known as MultiGig Ethernet) defines bandwidth capabilities of up to 2.5 Gbps and 5 Gbps over Cat5e and Cat6 copper cables. 10 Gbps bandwidth is even possible but requires network cable upgrades to Cat6a or Cat7. Enterprise vendors are now actively pushing sales of access switches that support these MultiGig speeds.

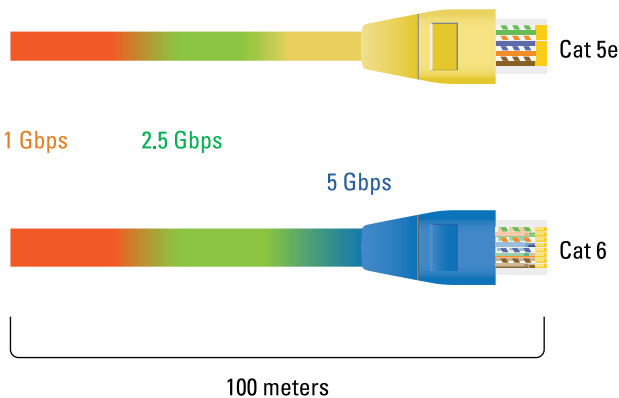

FIGURE 6-1: MultiGig Ethernet – 802.3bz.

So, one question is, “Will we need 2.5 Gbps Ethernet ports for Wi-Fi 6 access points?” The whole point of Wi-Fi 6 (802.11ax) is better spectrum efficiency and a reduction in airtime consumption. Logic dictates that if Wi-Fi becomes more efficient, the user traffic generated by a dual-frequency Wi-Fi 6 AP could potentially exceed 1 Gbps. The fear is that a standard Gigabit Ethernet wired uplink port could be a bottleneck, and therefore 2.5 Gbps uplink ports will be needed. As a precaution, WLAN vendors’ Wi-Fi 6 APs

will include at least one 802.3bz MultiGig Ethernet port capable of a 2.5 or 5 Gbps wired uplink. Think of this as future-proofing.

In the real world, we probably will still not exceed 1 Gbps for some time because of the following two reasons:

- » **Wi-Fi 6 client population:** Even though the chipset vendors are aggressively making Wi-Fi 6 client radios available at the same time as AP radios, it will take some time before the bulk of the enterprise client population is dominated by Wi-Fi 6 clients.
- » **Legacy clients drag us down:** Wi-Fi 6 requires backward compatibility with 802.11/a/b/g/n/ac, which means that RTS/CTS protection mechanisms must be used. RTS/CTS creates overhead and consumes airtime.

So, will customers have to upgrade their switches to have Multi-Gig capabilities? As I have already discussed, past gloom and doom predictions of access-layer bottlenecks have not come true. Although historically 1 Gbps uplinks have been more than enough, I am going to predict that at least 2.5 Gbps uplinks will be needed eventually. In the future, as Wi-Fi 6 client populations grow and as WLAN vendors add tri-band radios into their APs, 1 Gbps uplinks may no longer be sufficient. Any vendor claims that 10 Gbps uplinks will be needed are fantasy.

Power over Ethernet

Probably the much more important conversation about the relationship between switches and Wi-Fi 6 APs is Power over Ethernet (PoE) requirements. “Will Wi-Fi 6 APs work with standard 802.3af PoE?” In many cases, enterprise Wi-Fi manufacturers will be adding more radio chains to their Wi-Fi 6 access points. Many Wi-Fi 6 APs will be dual-band 4x4:4 APs and there will even be 8x8:8 APs. Wi-Fi 6 APs will also require much more processing power than previous generations of enterprise APs. The extra radio chains and processor capabilities will require more power. The 15.4 watts (W) provided per port by standard 802.11af PoE will not be adequate for 4x4:4 APs, and therefore 802.3at (PoE Plus) power will be necessary. PoE Plus-capable switches can provide up to 30 watts of power per Ethernet port. PoE Plus-powered ports for 4x4:4 APs should be considered a standard requirement.



TIP

If a business does not have PoE Plus-capable switches, they will have to upgrade if they are to deploy 4x4:4 APs. There is a good chance that many enterprise businesses already have switches with PoE Plus capabilities. But do the switches have enough power budget for a 1:1 replacement with 4x4:4 APs? What I am worried about is that many businesses will suddenly be exceeding the overall power budgets of the switches. Enterprise Wi-Fi vendors commonly receive support calls from customers complaining that all of the sudden, APs randomly begin to reboot. In most cases, the root cause of random rebooting of APs is that the switch power budget has been eclipsed. Very often, if an AP cannot get the power that it needs, the AP will reboot and try again. The power budget of a switch or multiple switches should be monitored to make sure that all devices can maintain power. Active power budget information can usually be seen from the command line of a switch or the GUI interface or monitored by a management solution such as ExtremeCloud IQ. An upgrade to 4x4:4 APs will at the very least require a recalculation of PoE power budgets. As WLAN vendors add more radio chains, dual-band radios and eventually tri-band radios, PoE power budget management will be of even greater importance moving forward.



TIP

Wi-Fi 6 2x2:2 APs will soon be entering the marketplace and in most cases standard PoE of 15.4 watts will be sufficient to power these APs.

Some WLAN vendors are selling 8x8:8 APs and the PoE power requirements are even more substantial. In some cases, these 8x8:8 APs will require 31 watts of power or more, which means that even PoE Plus power will be sufficient. While some of the 8x8:8 APs can be powered by 802.11at (PoE Plus), there is often some sort of downgrade functionality such as loss of USB, BLE radio, and so on.



TECHNICAL
STUFF

802.3bt is a new PoE standard that defines per-port power-source capabilities of 45 watts, 60 watts, 75 watts, and even 90 watts. Enterprise manufacturers have just begun to sell switches that support 802.3bt. Keep in mind that this technology is quite expensive. For now, PoE Plus (802.3at) will be sufficient to power the majority of Wi-Fi 6 APs. In the future, as WLAN vendors manufacture APs with even more radios under the hood, the need for 802.3bt power might become relevant.

4x4:4 versus 8x8:8

Probably the question I have been getting asked the most often is, “Which is better? 8x8:8 APs or 4x4:4 APs?” Several WLAN vendors are selling Wi-Fi 6 APs that have a 2.4 GHz radio that is 4x4:4 and a 5 GHz radio that is 8x8:8. These WLAN vendors are of course forging marketing pitches for 8x8:8. Eight must be better than four — right?

Theoretically, an 8x8:8 AP could modulate data on all eight radio chains to a single client which would result in some substantially high data rates. The problem is that there will never be any 8x8:8 mobile client devices due to the drain on battery life. As shown in Figure 6-2, we live in a world where the bulk of Wi-Fi client devices are 2x2:2. And depending on existing conditions, the clients will often downgrade to 1x1:1 communication.



FIGURE 6-2: 2x2:2 client capabilities and operational functionality.

So the primary advantage of an 8x8:8 AP over a 4x4:4 AP is MU-MIMO functionality. An 8x8:8 AP could modulate two independent streams of data each to four Wi-Fi 6 2x2:2 clients that support downlink MU-MIMO. Also, an 8x8:8 AP could transmit downlink one unique modulated stream of data to each of eight Wi-Fi 6 clients, simultaneously. While this sounds good in theory, I will refer you back to our MU-MIMO discussion in Chapter 3. MU-MIMO requires spatial diversity. Even if all Wi-Fi 6 clients support MU-MIMO, the majority of modern-day enterprise deployments of Wi-Fi involve a high density of users and devices that is not conducive for MU-MIMO conditions. MU-MIMO requires sizable physical distance between the clients, as well as the AP, for spatial diversity. Please reference Chapter 3.



TIP

You might read some marketing hype that 8x8:8 APs will support more clients than a 4x4:4 AP. As you learned in Chapter 2, OFDMA is the multi-user technology that holds the most promise for efficiency improvements. Regardless of the number of radio chains and regardless of stream count, all Wi-Fi 6 APs will support the same number of OFDMA clients during a transmission opportunity (TXOP).

Receive sensitivity refers to the power level of an RF signal required to be successfully received by the receiver radio. Will more radio chains in an 8x8:8 AP increase receive sensitivity? Yes, if an AP has more receiving radios and antennas, receive sensitivity will be better. An 8x8:8 could potentially add 3 dB better receive sensitivity. However, this also creates a potential downside. The receive sensitivity gains from eight radio chains will most likely increase the odds of co-channel interference (CCI) from clients that belong to other BSSs. Although Wi-Fi 6 BSS color and spatial reuse capabilities could offset the OBSS interference, real-world functionality of the BSS color capabilities in Wi-Fi 6 radios is not expected for a long time.

The receive sensitivity gains could also enhance *rate over range*, which means that higher data rates could be used over greater distance. However, in most cases, rate over range is an outdated concept for indoor Wi-Fi. Due to the high density of clients in the enterprise, most indoor Wi-Fi networks are designed for roaming, capacity, and reduced airtime consumption. Rarely are indoor enterprise WLANs designed primarily for range. Standard WLAN design of a received signal of -70 dBm will already result in clients using their highest data rate capabilities.

8x8:8 APs will be more expensive and will also be a bigger drain on the PoE power budget. While in theory the MU-MIMO gains sound enticing, the reality is that in most indoor enterprise deployments, an 8x8:8 AP offers no real advantage over a less expensive 4x4:4 Wi-Fi 6 AP. I will also make the argument that a Wi-Fi 6 AP with dual 5 GHz 4x4:4 radios will offer greater capacity capabilities than a Wi-Fi 6 AP with a fixed 2.4 GHz 4x4:4 radio and a 5 GHz 8x8:8 radio.

Extreme Networks offers a *software-defined radio* (SDR) along with a fixed 5 GHz radio within some models of dual-frequency Wi-Fi 6 APs. The radio that has SDR functionality can operate as either a 2.4 GHz or a 5 GHz radio. This means a dual-radio AP

can either offer 2.4 GHz and 5 GHz coverage or offer coverage on two different 5 GHz channels, as shown in Figure 6-3. The whole point behind dual 5 GHz coverage is to provide more capacity for clients. Providing dual 5 GHz coverage using 4x4:4 Wi-Fi 6 radios together with OFDMA mechanisms holds enormous capacity potential.

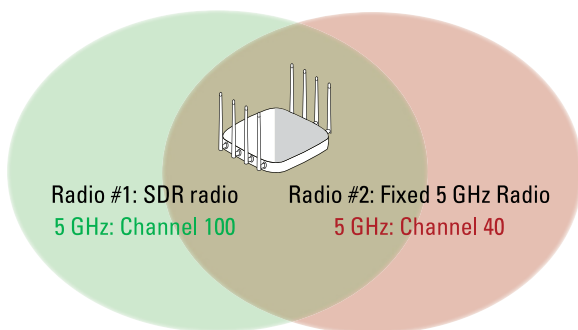

FIGURE 6-3: Wi-Fi 6 and dual 5 GHz APs.

80 MHz Channels

802.11ac introduced the capability of 80 MHz and even 160 MHz channels in the 5 GHz band. These large channels are created by bonding together multiple 20 MHz channels. Even though 80 MHz and 160 MHz channels are available with 802.11ac radios, they should not be used in enterprise. 80 MHz and 160 MHz channel implementations do not scale in an enterprise WLAN, because there is simply not enough frequency space and co-channel interference (CCI) is guaranteed to occur. Channel bonding also has a negative impact signal-to-noise ratio (SNR). Performance levels will drop significantly if 80 MHz channels are deployed on multiple APs in any enterprise environment.

Another question that is often asked is, “Will 80 MHz channels be usable in the enterprise with Wi-Fi 6 radios?” In theory, the Wi-Fi 6 adaptive CCA thresholds used together with BSS color have the potential to minimize OBSS interference. This would make 80 MHz channels enterprise deployments realistic using the current available 5 GHz frequency spectrum. As stated earlier in this chapter, although Wi-Fi 6 BSS color and spatial reuse capabilities could offset the OBSS interference, real-world functionality of the BSS color capabilities in Wi-Fi 6 radios is not expected

for a long time. In reality, 80 MHz and 160 MHz channel deployment in the enterprise will not scale until more unlicensed spectrum becomes available.



TIP

Channel bonding effectively doubles the frequency bandwidth, meaning double the data rates that can be available. 40 MHz channel reuse patterns can be effective in the 5 GHz band with good design best practices: Use all the dynamic frequency selection (DFS) channels with low power and think walls with high attenuation. Wi-Fi 6 APs can use OFDMA technology for simultaneous communications on a 40 MHz channel (see Chapter 2 for more info). For example, an AP could synchronize downlink or uplink transmissions with four Wi-Fi 6 clients each with an assigned 106-tone resource unit of frequency space within the 40 MHz channel.

- » Deploying Wi-Fi 6 in indoor high-density environments
- » Looking at Wi-Fi 6 for industrial environments
- » Using Wi-Fi 6 for outdoor high-density environments

Chapter 7

Extreme Wi-Fi 6 APs

Extrême Networks has a large portfolio of enterprise-grade Wi-Fi 6 access points (APs), which are designed for both indoor and outdoor high-density environments.

This chapter gives you a tour through Extreme Network's family of Wi-Fi 6 APs. Extreme Networks offers a substantial portfolio of enterprise Wi-Fi 6 APs with many different choices. Pick the one that best suits your needs.

AP505i

Extreme's AP505i is a high performance, enterprise class 802.11ax AP. Both the price and performance point are ideal for many different enterprise environments including retail, education, hospitality, and healthcare. These enterprises need to support a high density of users and Internet of Things (IoT) devices, while delivering an exceptional user experience. The AP505i is dual-frequency band indoor 4x4:4 AP.

AP510i and AP510e

Extreme's AP510i and AP510e also are high performance, enterprise class Wi-Fi 6 APs. They both offer high-density performance with software-defined dual 5 GHz radios. The AP510i is an indoor 4x4:4 AP with internal omni-directional antennas. It is designed to meet the coverage, capacity, and roaming needs in almost all enterprise environments. The AP510e indoor 4x4:4 AP has external antenna capabilities useful in industrial and manufacturing environments.

AP510C and AP510CX

The AP510C and AP510CX are designed for high performance environments. Both models also offer Extreme Network's software-defined radios (SDRs) capable of dual 5 GHz connectivity for indoor and industrial environments. AP510C and AP510CX have integrated BLE, Zigbee, and USB connectivity for enhanced location-driven services and the capability to provide additional wireless access options for IoT and other devices. All the Extreme indoor Wi-Fi 6 APs with internal antennas are designed for:

- » **High performance indoor environments:** Where HD video streaming, large file transfers, and HD video collaboration applications are necessary
- » **Very high client density environments:** Where density and performance are key requirements
- » **Wi-Fi-based VoIP:** Environments expecting to use VoWiFi in addition to data
- » **IoT:** Environments expected to use IoT applications like BLE at deployment or in the future

The Extreme indoor Wi-Fi 6 APs with external antennas are designed for:

- » **Industrial deployments like warehouses** running high-bandwidth applications and/or high client densities with extreme temperature ranges
- » **Lecture halls or auditorium-like environments** requiring specialized Wi-Fi setup using a mix of omni/sector antennas

AP560i, AP560h, and 560u

Extreme Networks offers three Wi-Fi APs for high-density outdoor environments. All three models offer software programmable modes to optimally manage for dual 5 GHz radios for the densest environments.





As the *Official Wi-Fi Solutions Provider of the NFL*, Extreme understands first-hand the challenges stadiums present. The AP560 series builds on that experience by delivering a custom-designed family of APs that cater specifically to stadiums and other high-density outdoor environments. The modular patent-pending design of outdoor Wi-Fi 6 APs supports a high density of users and devices, with an emphasis on a quality user experience.





The Extreme outdoor Wi-Fi 6 APs are designed for:

- » **High-density outdoor environments:** Used for HD video streaming and Internet connectivity in stadiums with tens of thousands of users and devices.
- » **Outdoor mobility:** Wi-Fi 6 mobility is key in outdoor areas such as parks, marinas, and campus grounds.
- » **Building-to-building connectivity:** When providing wireless backhaul between buildings in both campus and corporate grounds, high-bandwidth performance is key.

See Table 7-1 for a comparison of Extreme Network's Wi-Fi 6 family of APs.

TABLE 7-1 Extreme Networks Wi-Fi 6 AP Family

| | AP505i | AP510i | AP510e | AP510C |
|---------------------|---|---|---|---|
| |  |  |  |  |
| Environment | indoor - plenum | indoor - plenum | indoor - industrial | indoor - plenum |
| Antennas | internal | internal | external | internal |
| Bands | 2.4 GHz and 5 GHz | 2 GHz and 5 GHz - SDR radios for Dual 5 GHz | | |
| Capabilities | 4x4:4 downlink/uplink OFDMA & downlink MU-MIMO | | | |
| Security | WPA2/WPA3 | WPA2/WPA3 | WPA2/WPA3 | WPA2/WPA3 |
| Power | 802.3at (PoE+) - Some models operate with 802.3af with downgrade capabilities | | | |
| Ethernet | 2.5 GbE + 1GbE | 5 GbE + 1 GbE (PoE failover) | | 2.5 GbE + 1GbE (PoE failover) |
| IoT | BLE & USB | BLE & USB | BLE & USB | BLE, Zigbee & USB |

| | AP510CX | AP560i | AP560h | AP560u |
|---------------------|---|---|---|---|
| |  |  |  |  |
| Environment | indoor - industrial | outdoor | outdoor | outdoor |
| Antennas | external | omni | software selectable: 30° & 70° directional | omni: stadium seat |
| Bands | 2.4 GHz and 5 GHz - SDR radios for Dual 5 GHz | | | |
| Capabilities | 4x4:4 downlink/uplink OFDMA & downlink MU-MIMO | | | |
| Security | WPA2/WPA3 | WPA2/WPA3 | WPA2/WPA3 | WPA2/WPA3 |
| Power | 802.3at (PoE+) - Some models operate with 802.3af with downgrade capabilities | | | |
| Ethernet | 2.5 GbE + 1GbE (PoE failover) | 5 GbE + 1GbE (PoE failover) | | |
| IoT | BLE, Zigbee & USB | BLE & USB | BLE & USB | BLE & USB |



As you can see, almost the entire Extreme Networks Wi-Fi 6 AP portfolio offers software-defined radios (SDRs) along with a fixed 5 GHz radio within dual-frequency Wi-Fi 6 APs. The radio that has SDR functionality can operate either a 2.4 GHz, 5 GHz radio or as a sensor that can scan both bands. As a result of the software-defined capabilities, the APs can provide enormous client capacity using dual 5 GHz coverage with Wi-Fi 6 radios.

Our Wi-Fi 6 AP Family Is Growing!

Please welcome our newest additions to the Extreme family of Wi-Fi 6 APs. The AP305C and AP305CX are enterprise-grade, indoor APs based on a new system-on-a-chip (SoC) design. You have your choice of models with either integrated or external antennas. These 2x2:2 APs continue the Extreme tradition of software-defined radios (SDRs) capable of dual 5 GHz connectivity for indoor and industrial environments.

As shown in Figure 7-1, both the AP305C and the AP305CX showcase an aesthetic design and can fit in the palm of your hand. Both models are eco-friendly APs partially made from recycled materials. Also included is an integrated light sensor and integrated power meter to help conserve power consumption (future).



FIGURE 7-1: Extreme AP305C/CX – 2x2:2 Dual-5 GHz.

Be on the lookout soon for more Wi-Fi 6 APs from Extreme Networks including more dual 5 GHz APs, tri-radio APs, eco-friendly APs, and more! To learn more about our growing family of enterprise Wi-Fi 6 APs, please visit www.extremenetworks.com.

ExtremeCloud IQ

Introducing ExtremeCloud IQ, the third-generation cloud networking platform built on microservices for data durability. ExtremeCloud IQ management and monitoring capabilities provide network automation, insight, and assurance for your wireless and wired network. As shown in Figure 7-2, ExtremeCloud IQ scales globally and already manages over one million APs, over ten million daily connected clients, and over one million insights into data per second. The paradigm shift toward cloud-driven end-to-end enterprise networks parallels the Wi-Fi 6 paradigm shift for wireless connectivity.

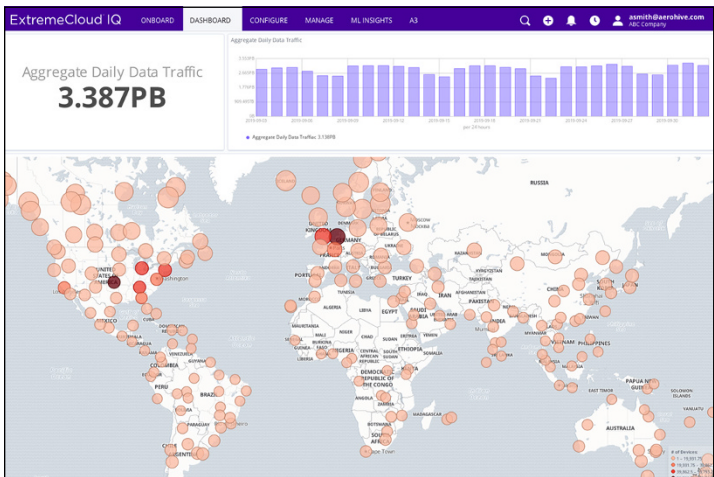

FIGURE 7-2: ExtremeCloud IQ.

Chapter 8

Ten Things to Know about Wi-Fi 6

In this chapter, I point out ten key things to keep in mind about Wi-Fi 6.

- » **It is a Wi-Fi paradigm shift.** Wi-Fi 6 does not just push the envelope with regard to Wi-Fi speeds — up to 10 Gbps. It introduces numerous performance improvements as well. In fact, it has been dubbed “High Efficiency” unlike previous versions that were labeled “High Throughput.” Wi-Fi 6 is not just about better throughput. Wi-Fi 6 substantially improves capacity, provides better coverage, and reduces congestion in Wi-Fi networks.
- » **Look forward to a little backward compatibility.** Unlike the 802.11ac standard, 802.11ax and Wi-Fi 6 support both 2.4 and 5 GHz wireless devices, so 802.11n (and potentially 802.11g and 802.11b) devices are able to run on Wi-Fi 6 networks. This is critical for many legacy specialized devices, particularly in healthcare and manufacturing verticals that tend to move slowly to update their devices.

- » **Do not confuse your multi-user technologies.** The term multi-user (MU) simply means that transmissions between an AP and multiple clients can occur at the same time, depending on the supported technology. However, the MU terminology can be very confusing when discussing Wi-Fi 6. Multi-user capabilities exist for both OFDMA and MU-MIMO. There are key differences between both Wi-Fi 6 multi-user technologies.
- » **RU ready for simultaneous multi-user Wi-Fi access?** Multi-user *orthogonal frequency division multiple access (OFDMA)* is easily the most important new capability introduced with Wi-Fi 6. It subdivides a channel into smaller frequency allocations, called *resource units (RUs)*, thereby enabling an access point (AP) to synchronize communication (uplink and downlink) with multiple individual clients assigned to the RUs.
- » **MU-MIMO enhancements are here.** More MU-MIMO clients can communicate with an AP at the same time. Wi-Fi 5 is limited to a MU-MIMO group of only four clients, whereas Wi-Fi 6 potentially supports up to 8x8x8 MU-MIMO in both downlink and uplink, which allows it to serve up to eight users simultaneously. MU-MIMO is a great multi-user technology for PtMP wireless bridge links between buildings.
- » **No more OBSSessing over spatial reuse.** Wi-Fi 6 radios are able to differentiate between BSSs using a BSS color identifier when other radios transmit on the same channel. Using a procedure called spatial reuse operation (SRO), Wi-Fi 6 radios can apply adaptive clear channel assessment (CCA) thresholds. BSS color together with SRO have the potential to decrease the overlapping basic service set (OBSS) channel contention problem that is prevalent in most enterprise WLANs.
- » **No qualms about higher data speeds either.** Wi-Fi 6 supports 1024-QAM modulation and coding schemes (MCS) that define higher data rates providing a potential 20 percent increase in data throughput over 256-QAM (introduced in Wi-Fi 5).

- » **You need more power.** Many Wi-Fi 6 APs are dual-band 4x4:4 APs, and some are even 8x8:8 APs. The extra radio chains and processor capabilities require more power. The 15.4 watts provided by standard 802.11af PoE is not adequate. 802.3at (PoE+) power often is required. PoE+ requirements for 4x4:4 APs should be considered a standard requirement. This may require upgrades of access-layer switches as well as the recalculation of PoE power budgets.
- » **Wi-Fi 6 is great for IoT.** Many of the efficiency enhancements for Wi-Fi 6 hold great promise for future IoT devices. Target wake time (TWT) is an ideal power-saving mechanism, for mobile devices and Internet of Things (IoT) devices that need to conserve battery life. The 20 MHz-only operational mode is ideal for IoT clients that may not need the full capabilities that Wi-Fi 6 has to offer. This will allow client manufacturers to design less complex chipsets at a lower cost, which is ideal for IoT devices.
- » **Wi-Fi security will be better.** Although Wi-Fi 6 itself, does not specify any new security enhancements or requirements, it does require WPA3 security as a prerequisite. The Wi-Fi Protected Access Version 3 (WPA3) security certification, introduces security enhancements, most importantly, Simultaneous Authentication of Equals (SAE) as a replacement for WPA2-Personal's Pre-Shared Key (PSK).



Extreme Elements™

Real Tech. Really Human.



#20YearsofWiFi and a new generation: Wi-Fi 6

Past 802.11 wireless enhancements have delivered higher data rates and wider channels but haven't addressed efficiency challenges in Wi-Fi networks. Wi-Fi traffic jams are still inevitable. Despite the higher data rates and the 40/80/160 MHz channels used by 802.11n/ac radios, multiple factors create traffic congestion in Wi-Fi networks. Wi-Fi 6 focuses on *high efficiency* with technology to address the inefficient use of the Wi-Fi medium.

Inside...

- Understand current Wi-Fi challenges
- Learn how OFDMA improves efficiency
- Implement downlink and uplink multi-user (MU) communication
- Extend Wi-Fi client device battery life with TWT
- Recognize real-world deployment considerations



Extreme™
Customer-Driven Networking

David Coleman is Director of Product Marketing at Extreme Networks and the co-author of numerous books about Wi-Fi technology.

Go to **Dummies.com**™
for videos, step-by-step photos,
how-to articles, or to shop!

for
dummies®
A Wiley Brand

ISBN: 978-1-119-64285-5



WILEY END USER LICENSE AGREEMENT

Go to www.wiley.com/go/eula to access Wiley's ebook EULA.